

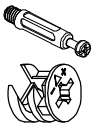

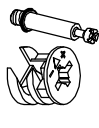

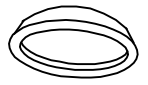





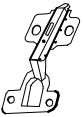
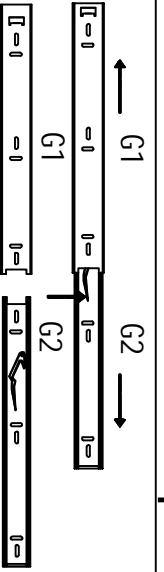
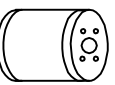
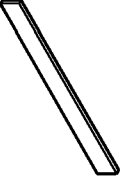

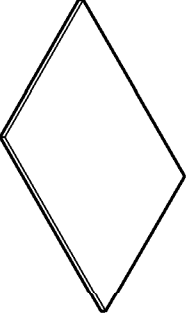



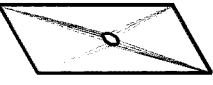

A 34pcs 	B 8pcs 	C 4pcs 	D 48pcs 	E 17pcs 
F 4pcs 	G 2pcs 		H 4pcs 	

				
① 866 * 82mm=1pcs	② 698 * 82mm=1pcs	③ 698 * 82mm=1pcs	④ 900 * 700mm=1pcs	⑤ 770 * 370mm=1pcs
				
⑥ 770 * 370mm=1pcs	⑦ 770 * 370mm=1pcs	⑧ 770 * 370mm=1pcs	⑨ 356 * 150mm=2pcs	⑩ 780 * 352mm=2pcs
				
⑪ 780 * 160mm=1pcs	⑫ 582 * 374mm=1pcs	⑬ 582 * 374mm=1pcs	⑭ 350 * 140mm=2pcs	⑮ 298 * 140mm=2pcs
				
⑯ 350 * 140mm=2pcs	⑰ 374 * 180mm=2pcs	⑱ 347 * 308mm=2pcs	⑲ 900 * 390mm=1pcs	



5

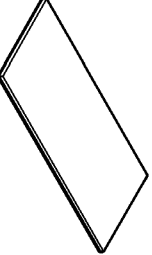
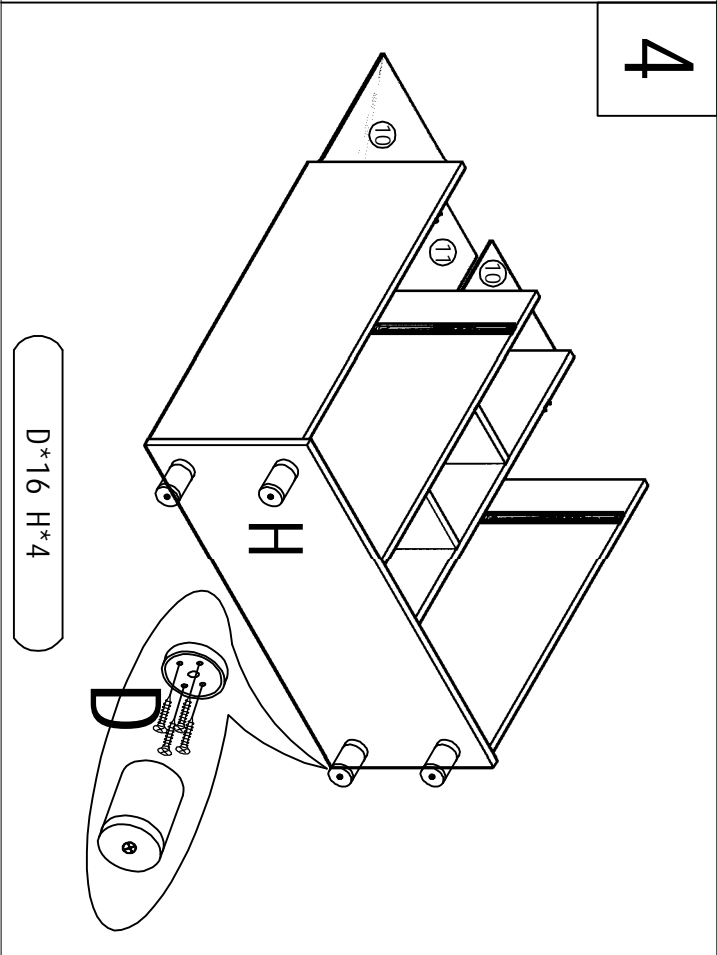
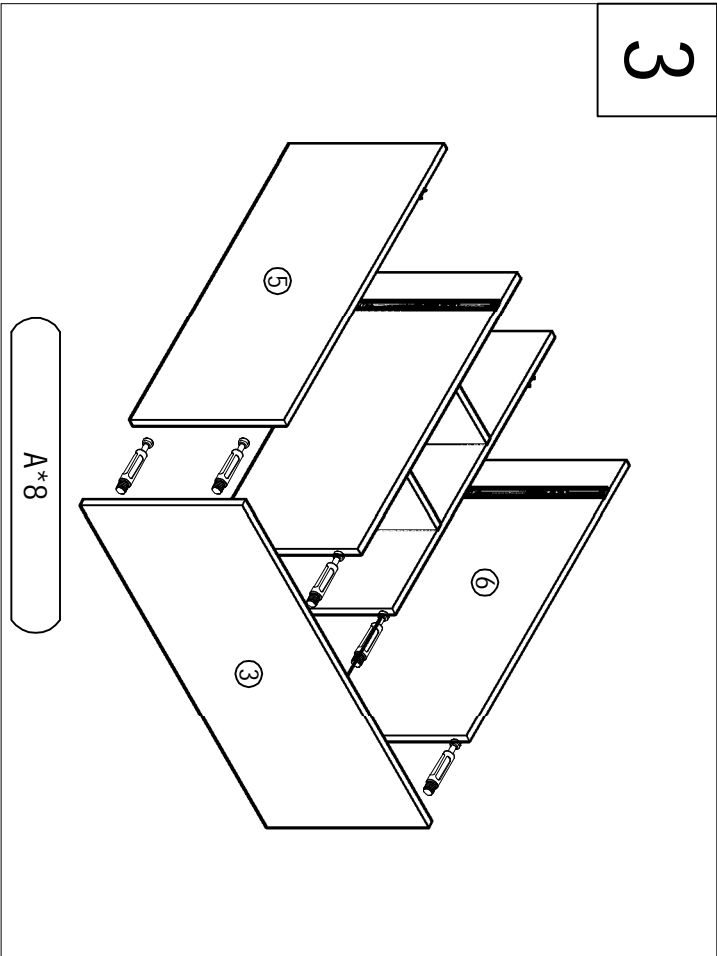
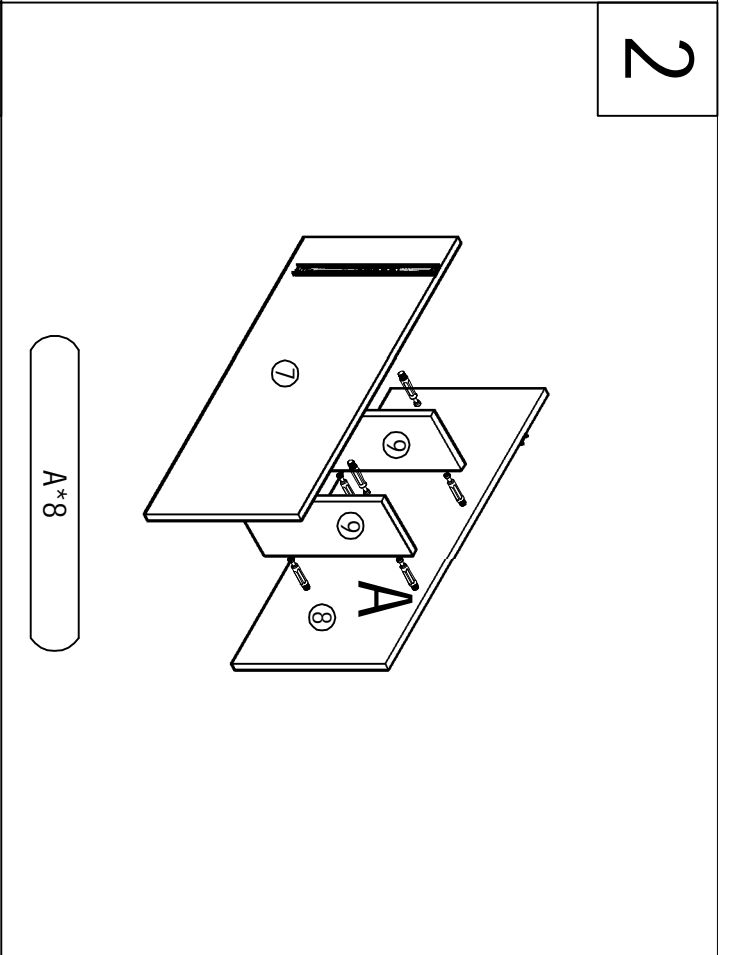
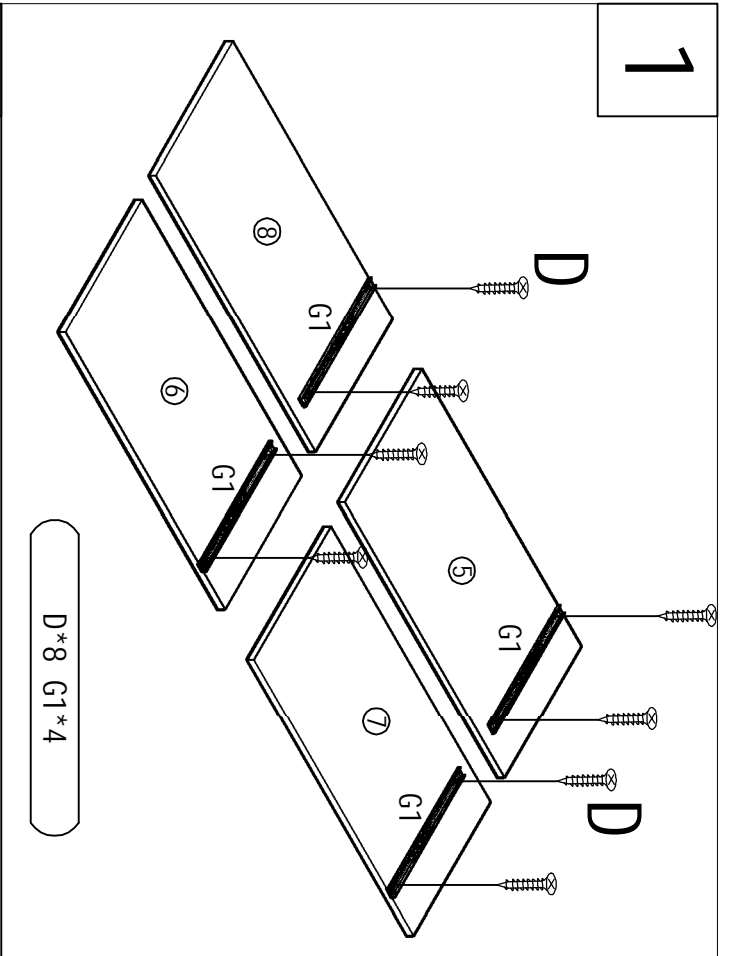
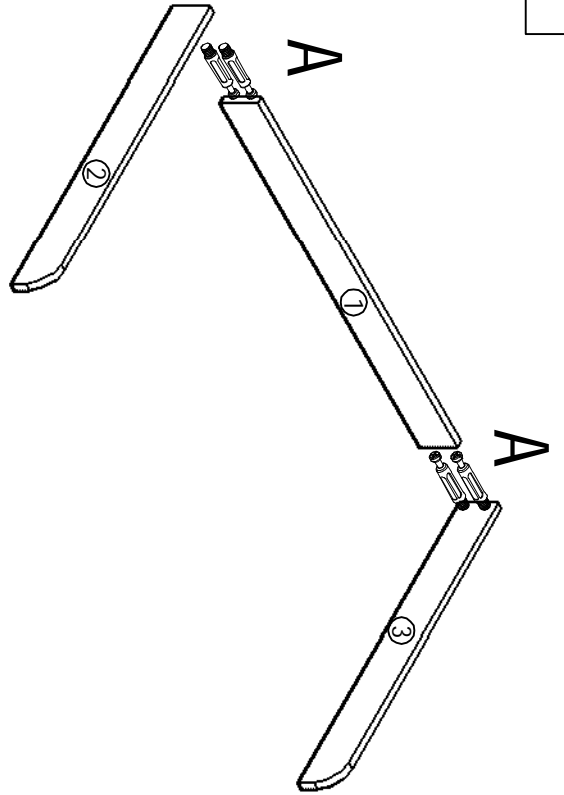

A*4

6

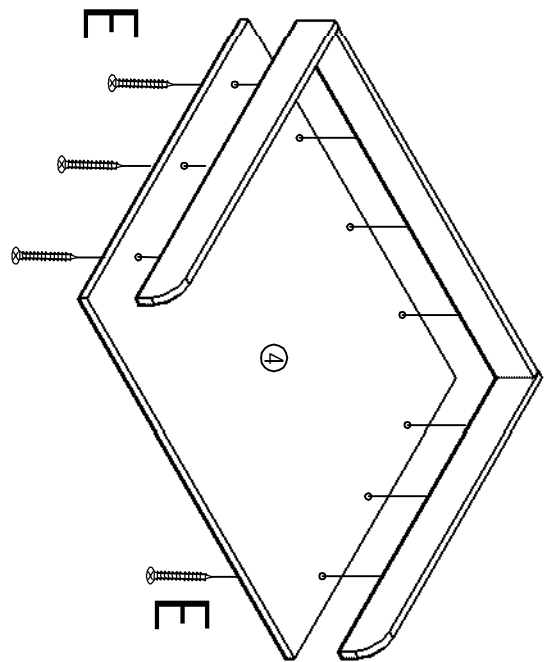

E*9

7

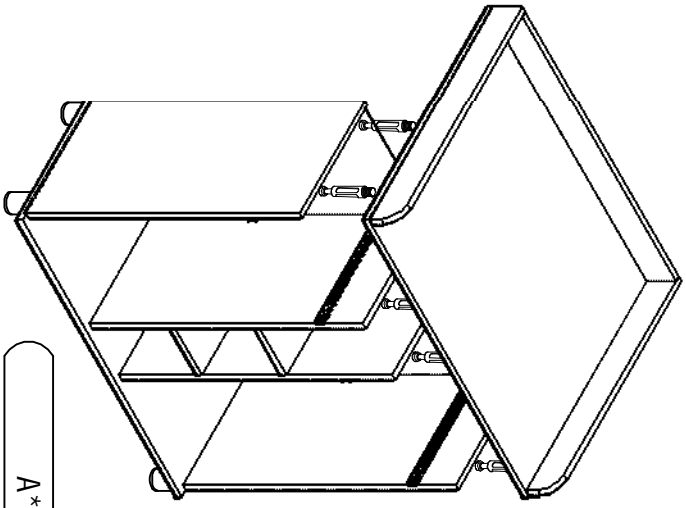

A*8

8

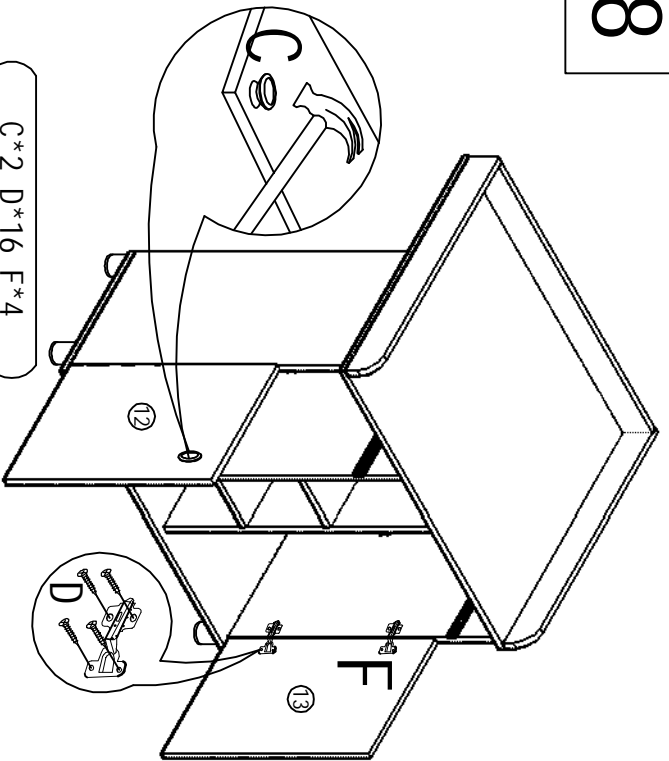

C*2 D*16 F*4

9

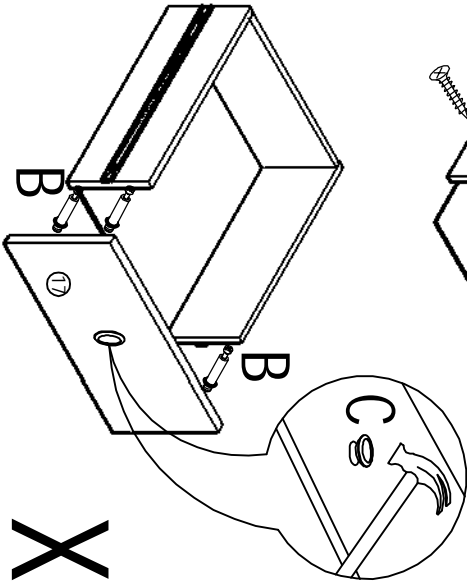
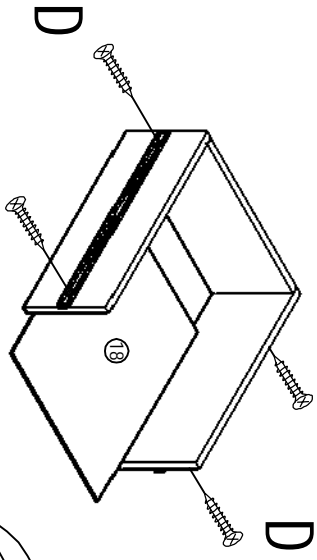
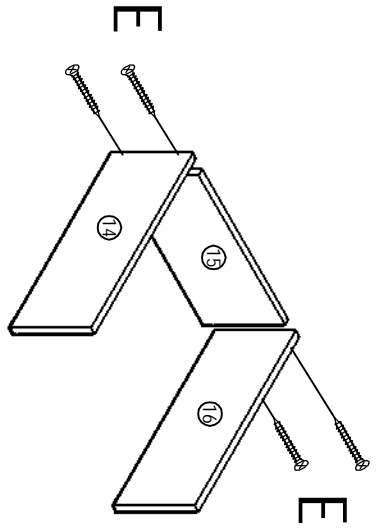

B*8 C*2 D*8 E*8 G2*4

X3

10

