













Hardware List

A		12 pcs	E	 3*14mm	2 pcs	I		1 pc
B		12 pcs	F	 4*30mm	4 pcs	J		1 pc
C		12 pcs	G		2 pcs	k		2 pcs
D	 3*10mm	6 pcs	H		2 pcs	L		1 pc





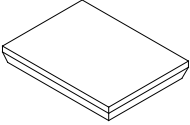
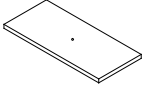
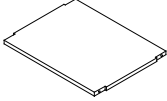
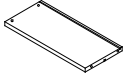
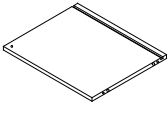
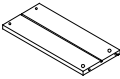
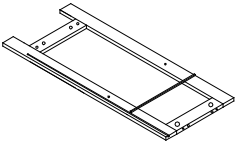
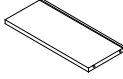
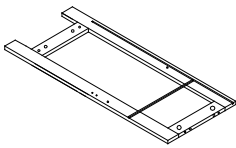
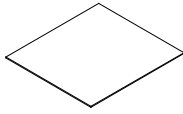
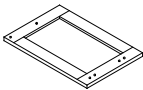
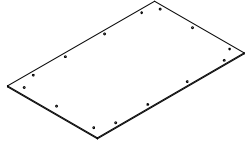

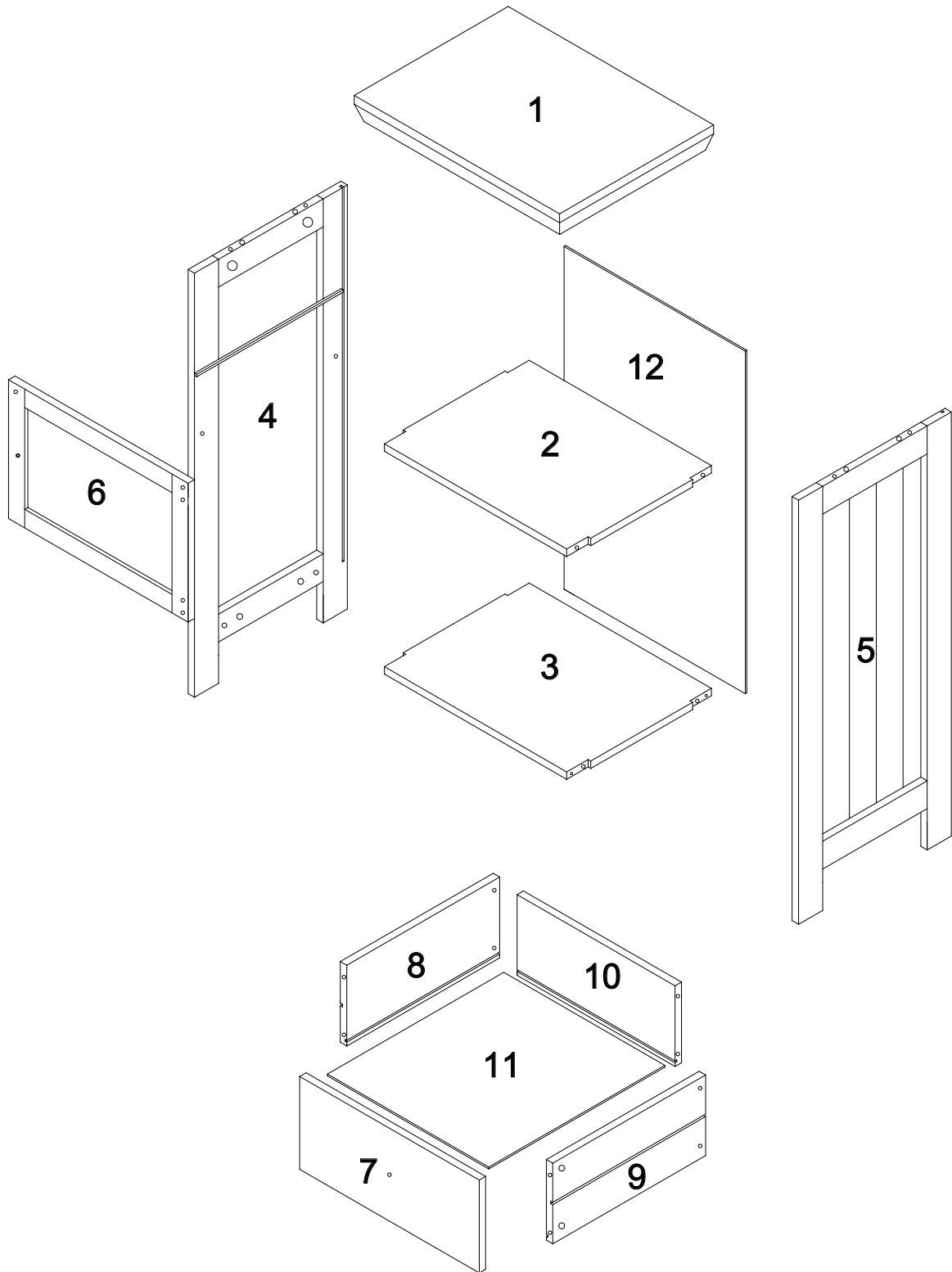
Parts List

1		1 pc	7		1 pc
2		1 pc	8		1 pcs
3		1 pc	9		1 pcs
4		1 pc	10		1 pc
5		1 pc	11		1 pcs
6		1 pc	12		1 pcs

Part List Assembly Overview



Step 1

A		12 pcs
D		4 pcs
E		2 pcs
I		1 pc
J		1 pc
K		1 pc
L		1 pc

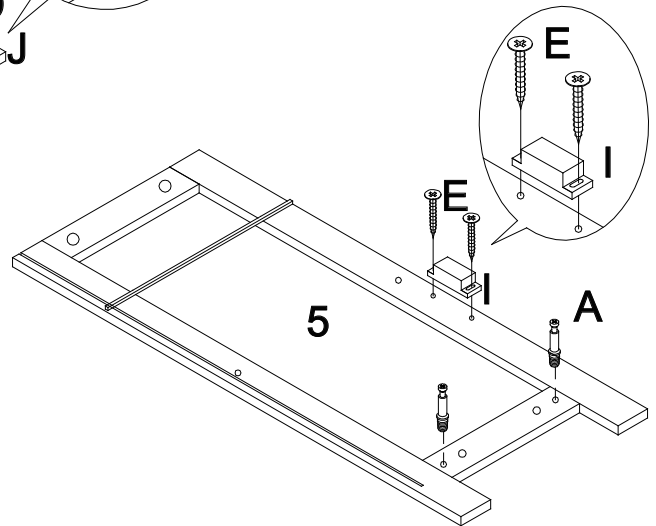
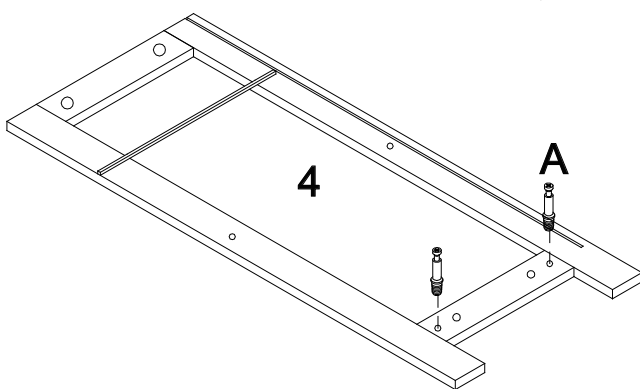
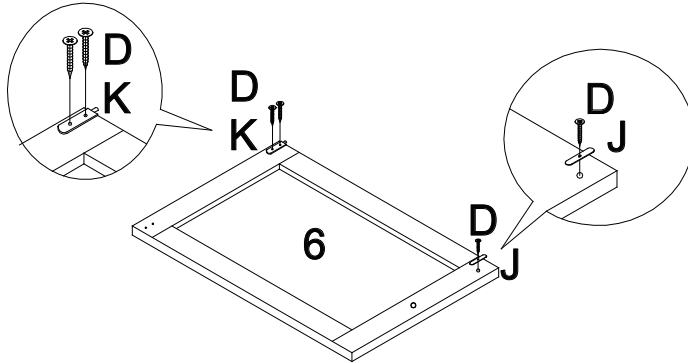
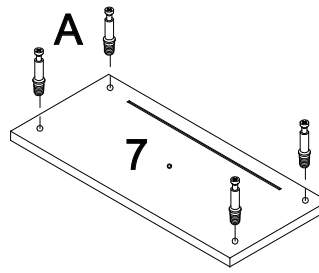
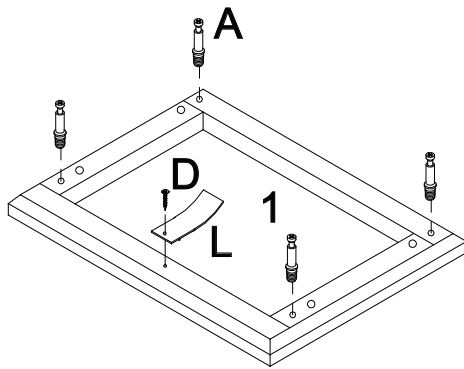

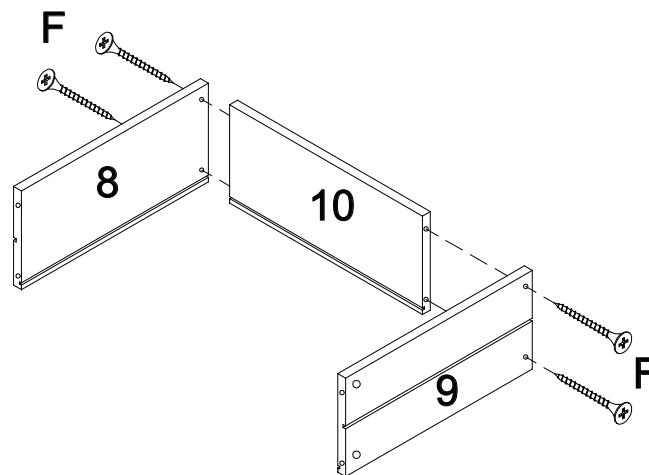

Step 2

F		4 pcs
---	---	-------



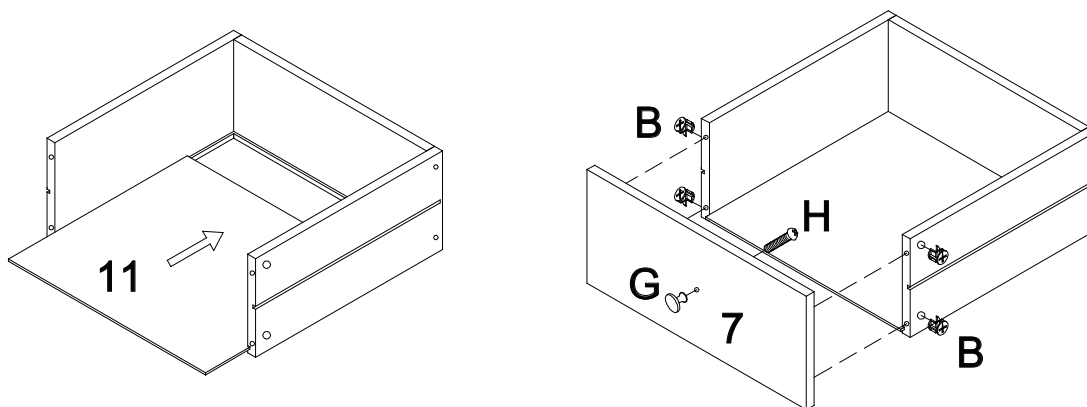

Step 3

B		4 pcs
G		1 pc
H		1 pc





Step 4

B		2 pcs
C		4 pcs



Step 5

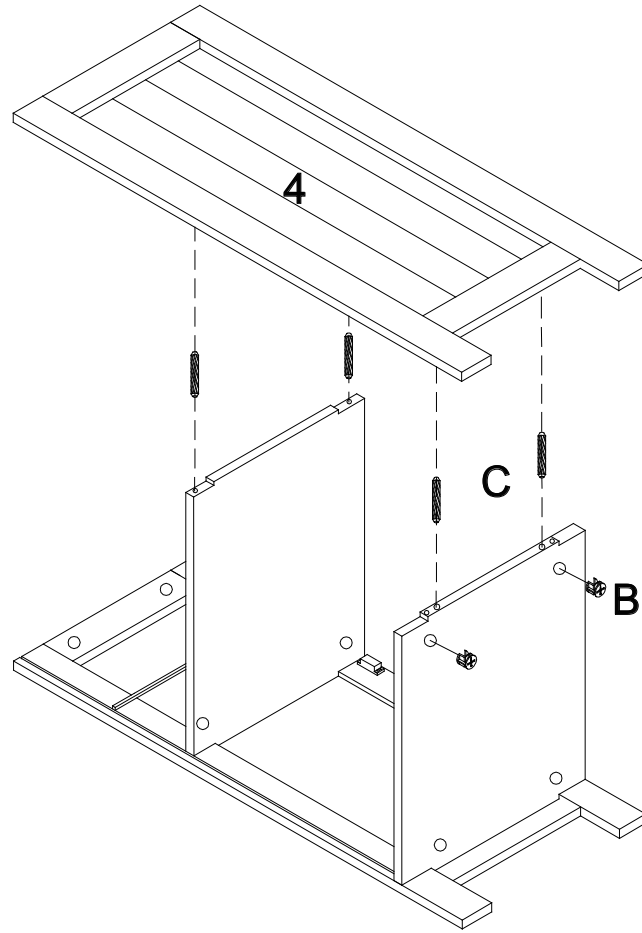

B		2 pcs
C		4 pcs

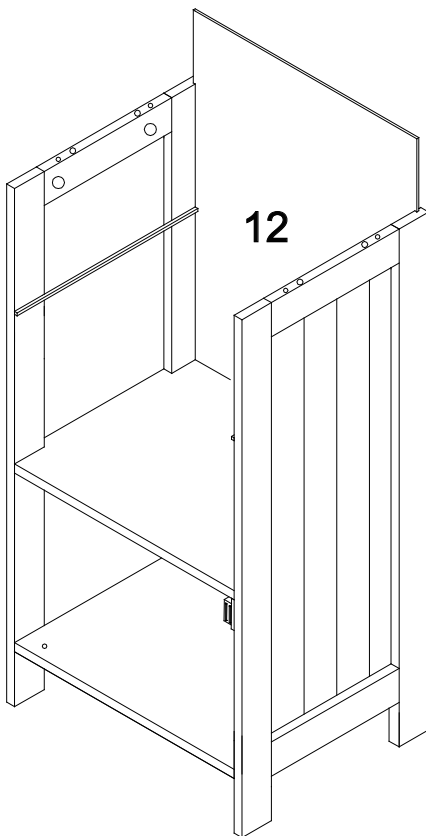

Step 6





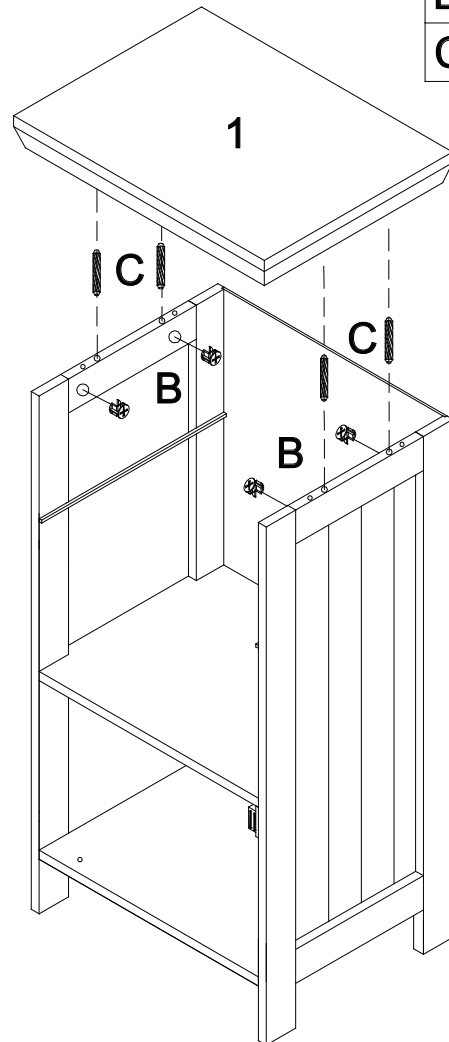

Step 7

B		4 pcs
C		4 pcs



Step 8

D		2 pcs
G		1 pc
H		1 pc
L		1 pc

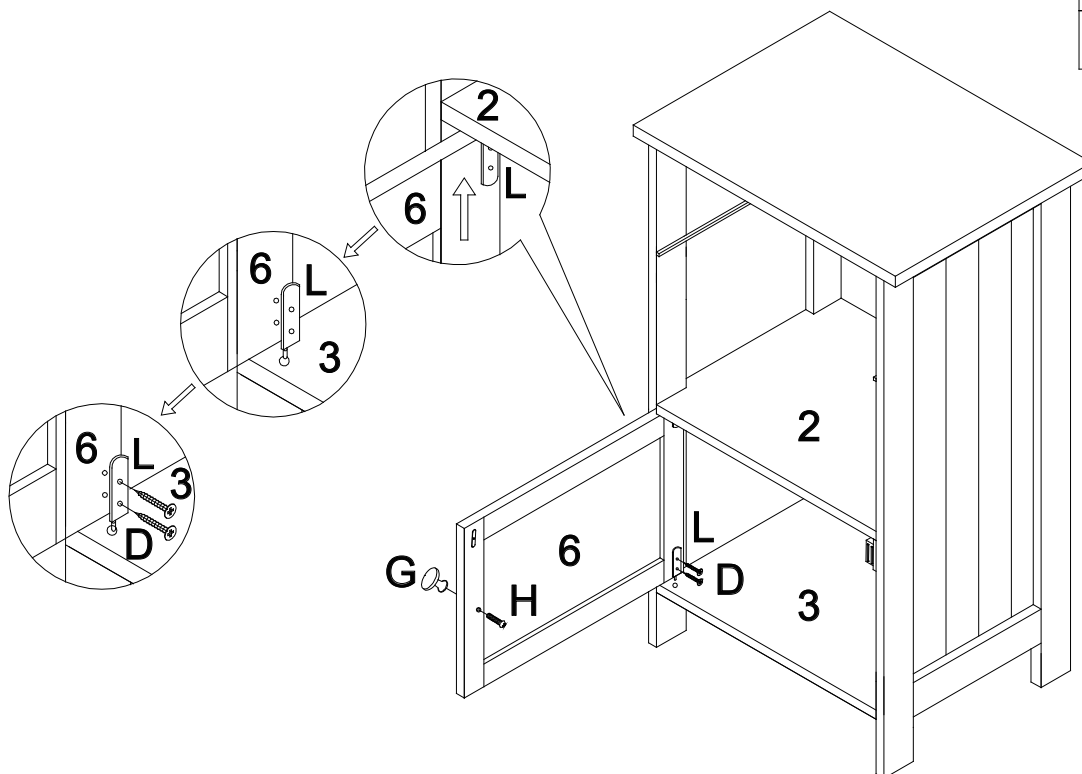

Step 9

