

HW61364-4W

1

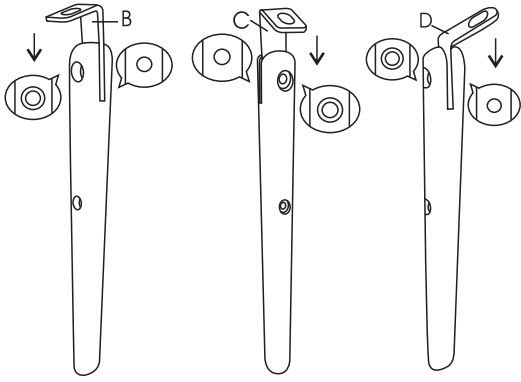

PLEASE PAY ATTENTION TO THE PLACEMENT OF THE TOP METAL PART

2

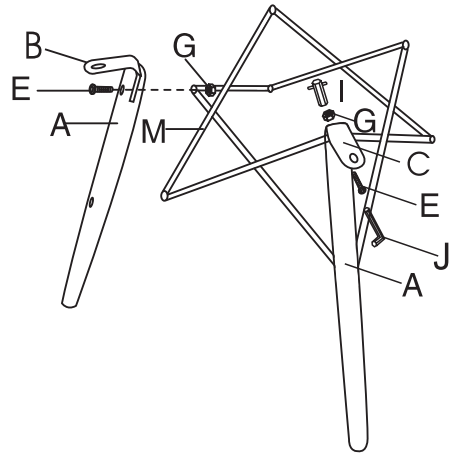

3

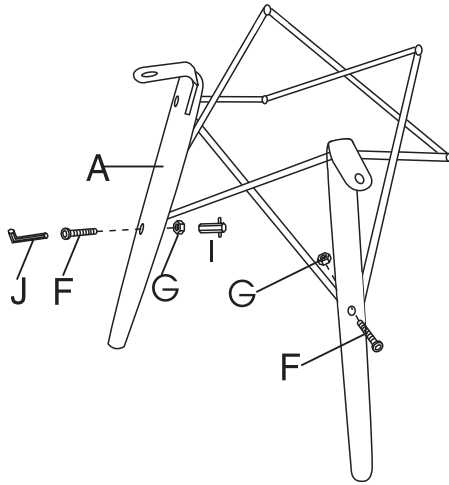

4

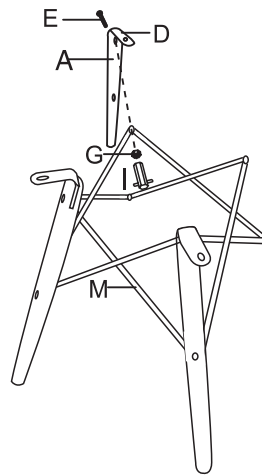

5

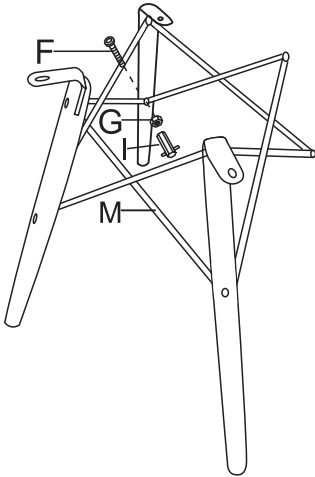

6

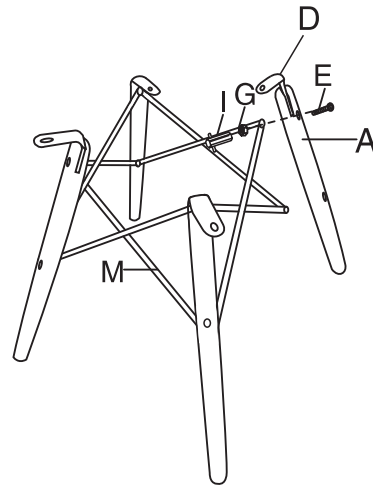

7

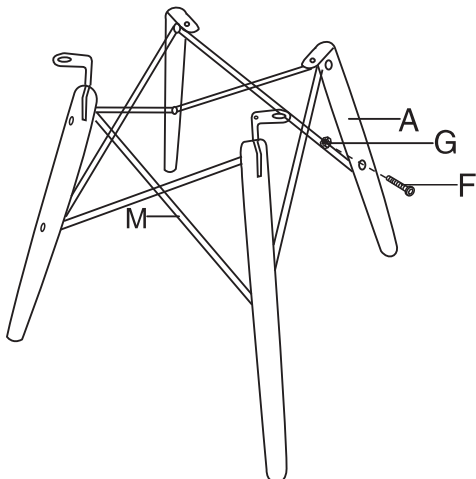

8

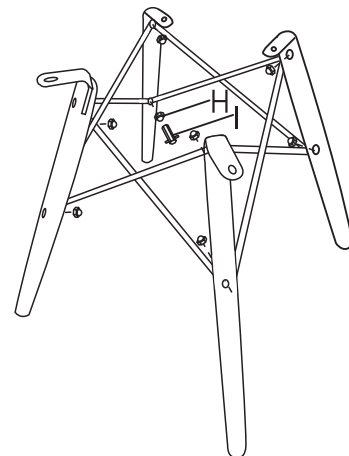

9

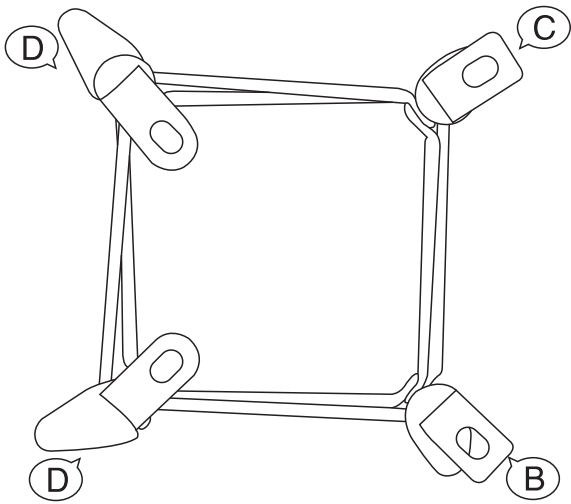

FRAME FINISHED

10

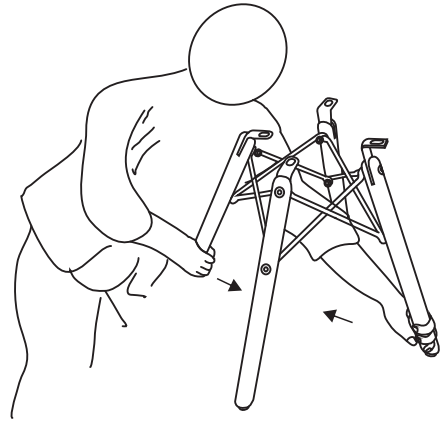





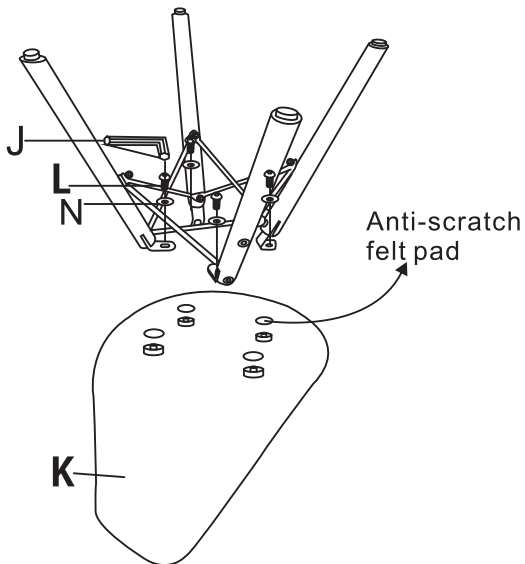









REMARK : IF THE WOOD LEG IS UNEVEN AFTER ASSEMBLY , (1) PLEASE LOOSEN THE SCREW , ADJUST THE ANGLE , AND THEN TIGHTEN IT AGAIN ; (2) .USE DIAGONALS TO LEVELING THE WOODEN LEGS.

11



12





A		4	H		8
B		1	I		1
C		1	J		1
D		2	K		1
E	 6x32mm	4	L	 6x12mm	4
F	 6x35mm	4	M		1
G		8	N		4

REMARK : AN EXTRA SPARE PART "G " IS ADDED.

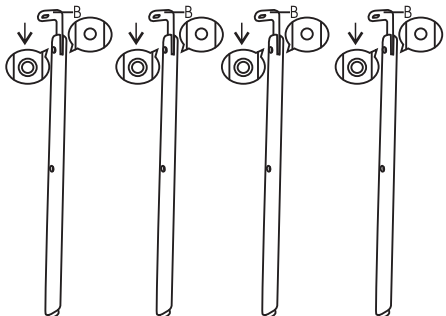
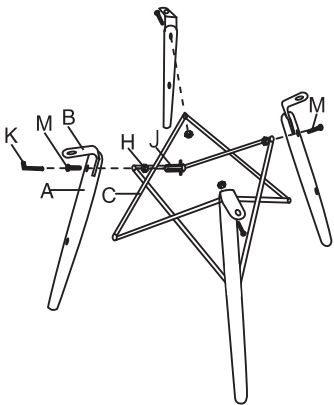
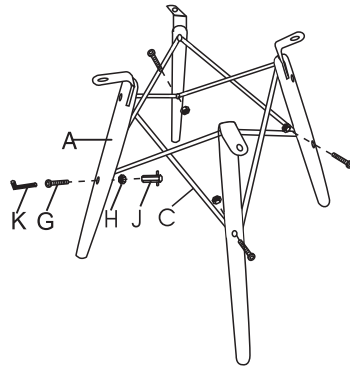
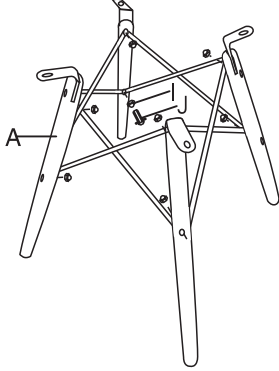
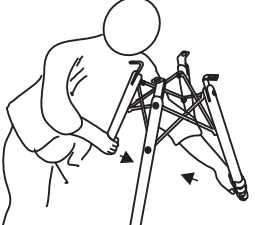
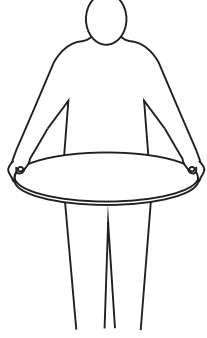
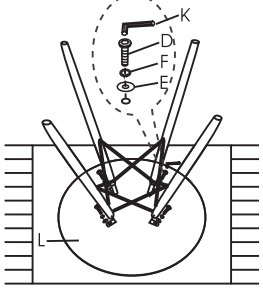
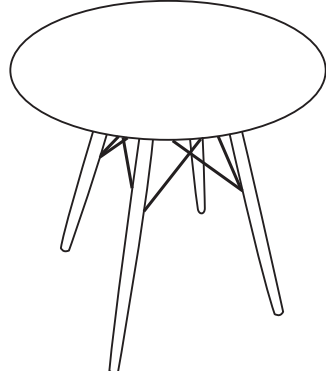
HW61364-4W

<p>1</p>  <p>PLEASE PAY ATTENTION TO THE PLACEMENT OF THE TOP METAL PART</p>	<p>2</p> 
<p>3</p> 	<p>4</p> 
<p>5</p>  <p>REMARK : IF THE WOOD LEG IS UNEVEN AFTER ASSEMBLY , (1) PLEASE LOOSEN THE SCREW , ADJUST THE ANGLE , AND THEN TIGHTEN IT AGAIN ; (2) .USE DIAGONALS TO LEVELING THE WOODEN LEGS.</p>	<p>6</p>  <p>PLEASE ALWAYS KEEP THE TABLE TOP IN A HORIZONTAL POSITION TO AVOID BEING BUMPED.</p>
<p>7</p>  <p>PLEASE ALWAYS KEEP THE TABLE TOP IN A SOFT AND DRY PLACE WHEN ASSEMBLING TO AVOID SCRATCH</p>	<p>8</p> 

A		4	F		4	K		1
B		4	G	 6x35mm	4	L		1
C		1	H		8	M	 6x32mm	4
D	 6x18mm	4	I		8			
E		4	J		1			

REMARK : AN EXTRA SPARE PART "H " IS ADDED.