



**Please give us a chance to make it right and do better !**

Contact our friendly customer service department for help first.

Replacements for missing or damaged parts will be shipped ASAP !

US office: Fontana      UK office: Ipswich

**COSTWAY®**

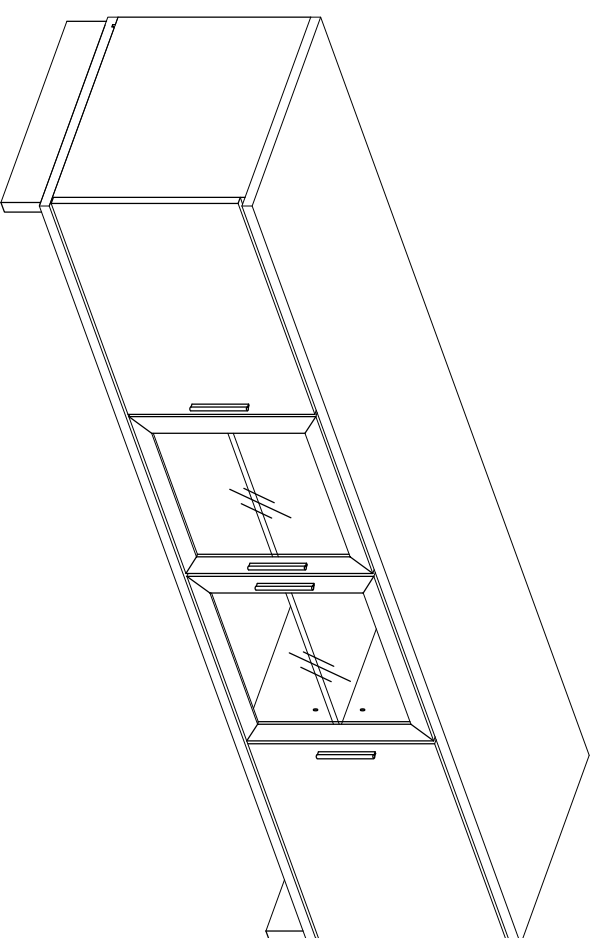

**USER'S MANUAL**

**Entertainment Unit  
HW65143**

**Contact Us !**

**Do NOT return this item.**

Contact our friendly customer service department for help first.



US:cs.us@costway.com  
UK:cs.uk@costway.com

THIS INSTRUCTION BOOKLET CONTAINS **IMPORTANT** SAFETY INFORMATION. PLEASE READ AND KEEP FOR FUTURE REFERENCE.



# Before You Start

- ⚠ Read each step carefully before starting. It is very important to ensure each step followed in correct order, otherwise assembly difficulties may occur.
- ⚠ Most of board parts are labeled or stamped on the raw edges. Have a check to make sure all parts are included.
- ⚠ Work in a spacious area, preferably on a carpet close to where the unit will be used.
- ⚠ Keep the handtools close at hand. Do not use power tools to assemble your furniture. They may scratch or damage the parts.

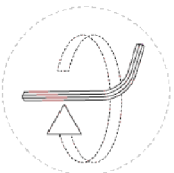
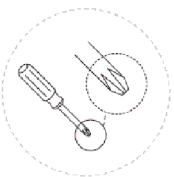
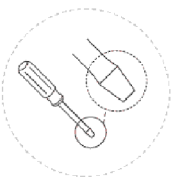

# Care and Maintenance

Use a soft, clean cloth that will not scratch the surface when dusting.

Use of furniture polish is not necessary.

Should you choose to use polish, test first in an inconspicuous area.

Using solvents of any kind on your furniture may damage the finish.

Never use water to clean your furniture as it may cause damage to the finish.

Liquid spills should be removed immediately. Using a soft clean cloth, blot the spill gently. Avoid rubbing.

Check bolts/screws periodically and tighten them if necessary.

## Further advice about wood furniture care









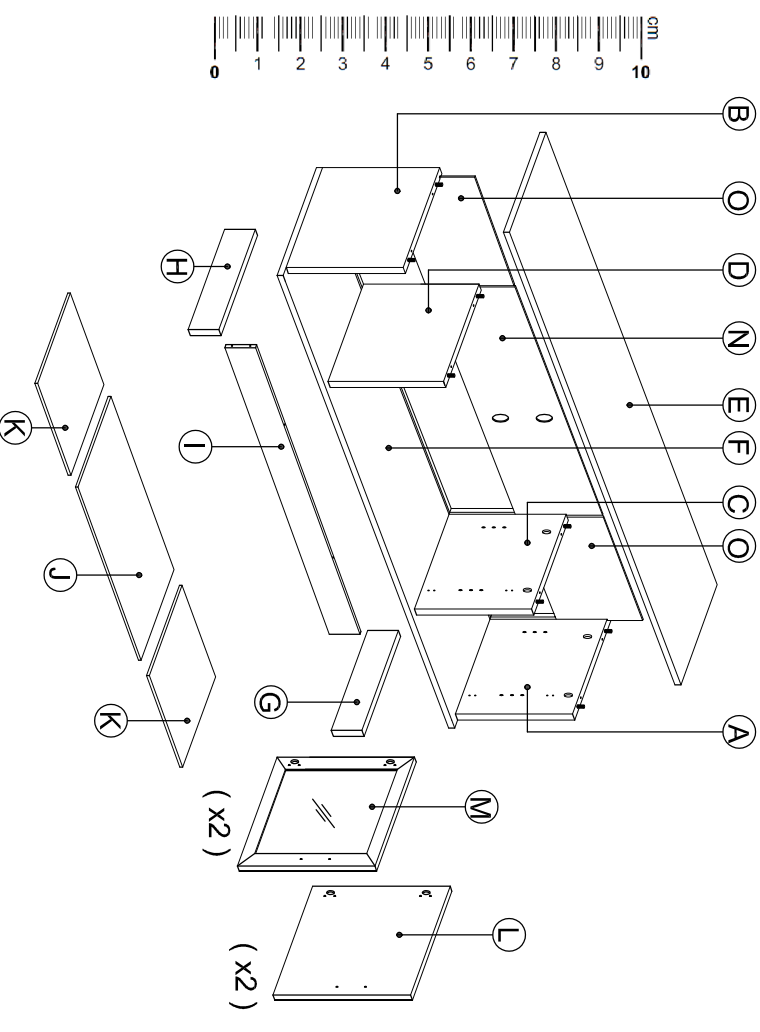
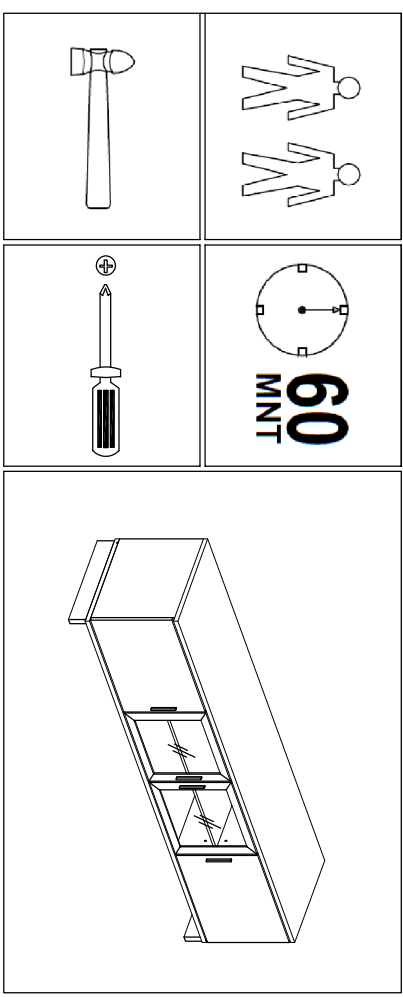



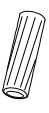

It is best to keep your furniture in a climate-controlled environment. Extreme temperature and humidity changes can cause fading, warping, shrinking and splitting of wood.

It is advised to keep furniture away from direct sunlight as sun may damage the finish.

Proper care and cleaning at home will extend the life of your purchase.

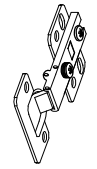

Following these important and helpful tips will enhance your furniture as it ages.

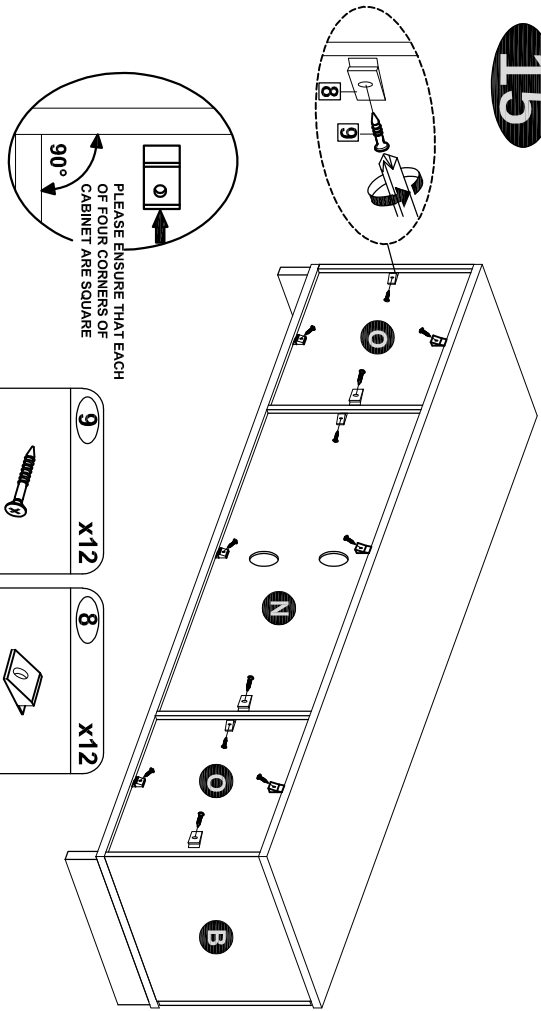

<b>1</b>	<b>x1</b>		Glue 10cc
<b>2</b>	<b>x4</b>		2/8 <b>x4</b>
<b>3</b>	<b>x16</b>		Dia 15mm 12mm <b>x16</b>
<b>4</b>	<b>x16</b>		M6 5 x 32mm <b>x16</b>
<b>5</b>	<b>x20</b>		Dia 6 x 30mm <b>x20</b>
<b>6</b>	<b>x4</b>		HANDLE <b>x4</b>
<b>7</b>	<b>x6</b>		Ø15 x 23mm <b>x6</b>
<b>8</b>	<b>x12</b>		BACKPLY STOPPER <b>x12</b>
<b>9</b>	<b>x12</b>		M3 x 20mm <b>x12</b>
<b>10</b>	<b>x8</b>		M5 x 40mm <b>x8</b>
<b>11</b>	<b>x8</b>		M4 x 19mm <b>x8</b>
<b>12</b>	<b>x32</b>		M4 x 16mm <b>x32</b>
<b>13</b>	<b>x4</b>		5/8 <b>x4</b>
<b>14</b>	<b>x12</b>		Dia 5 x 16mm <b>x12</b>

**15**



<b>9</b>	<b>x12</b>		M3 x 20mm
<b>8</b>	<b>x12</b>		BACKPLY STOPPER

**16**

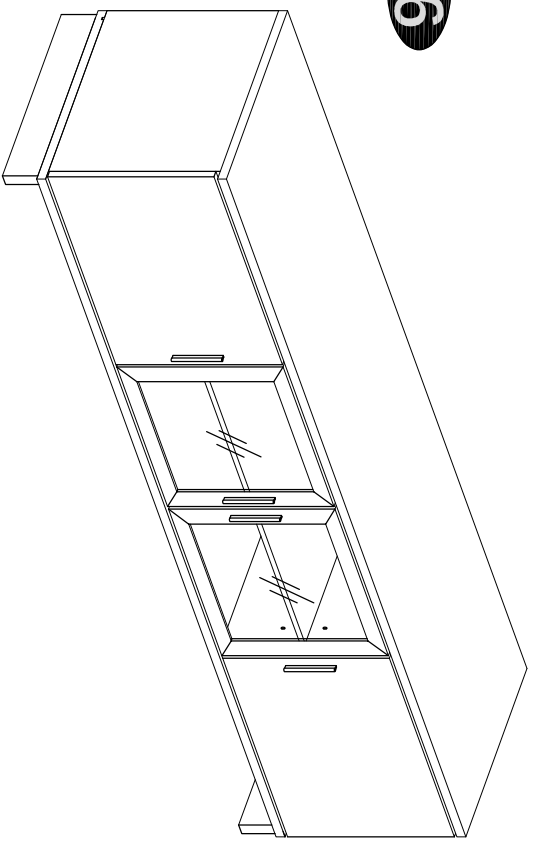

NOTE : THE MAXIMUM WEIGHT ON TOP PANEL UP TO 35KGS / 5KGS MAX WEIGHT PER SHELF .

14

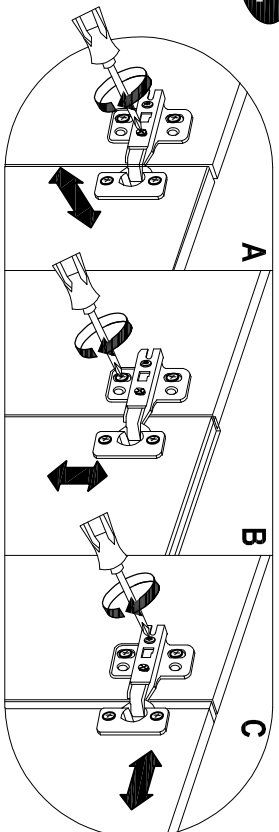

- A. Turn front screw to adjust door overlay (sideway).
- B. Rotate cam screw on mounting plate to adjust door height.
- C. Turn rear screw for door depth adjustment.

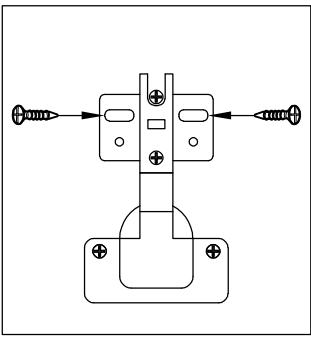

1

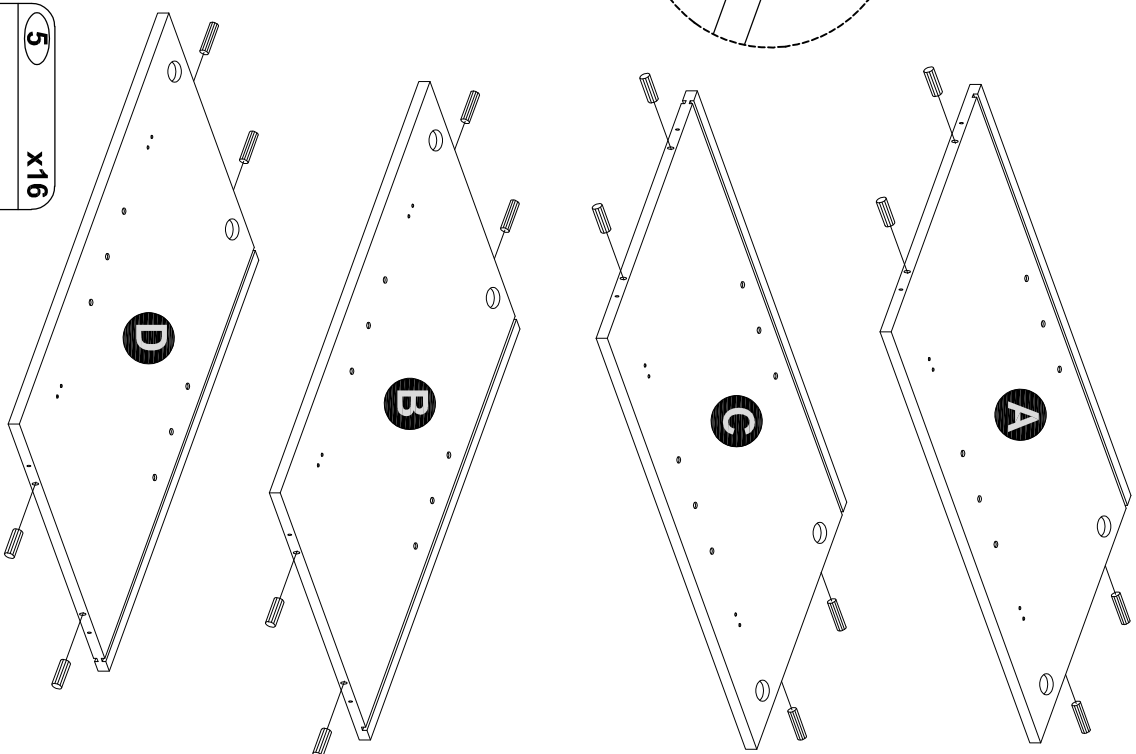
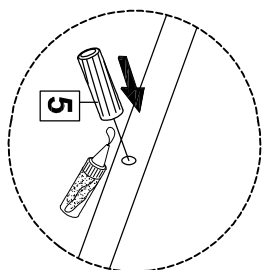

- 1 x1 Glue 10cc
- 5 x16 Dia 6 x 30mm

- 12 x8 M4 x 16mm

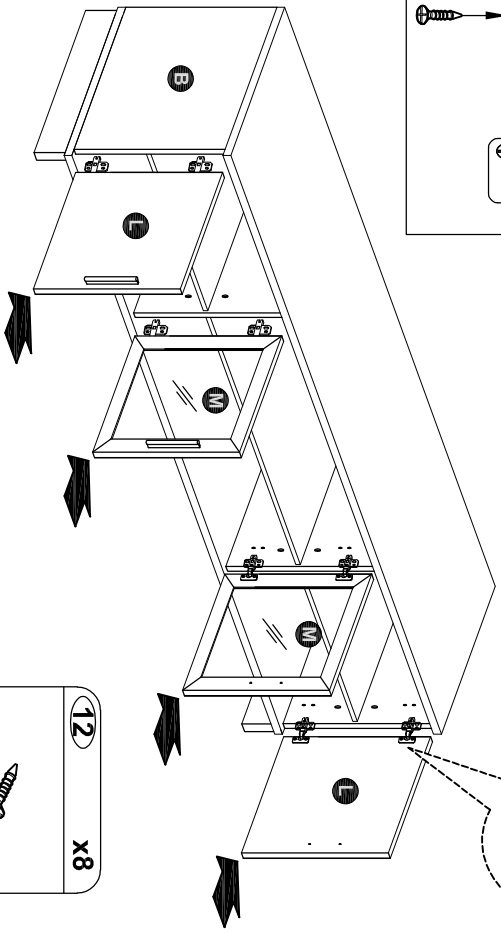

2

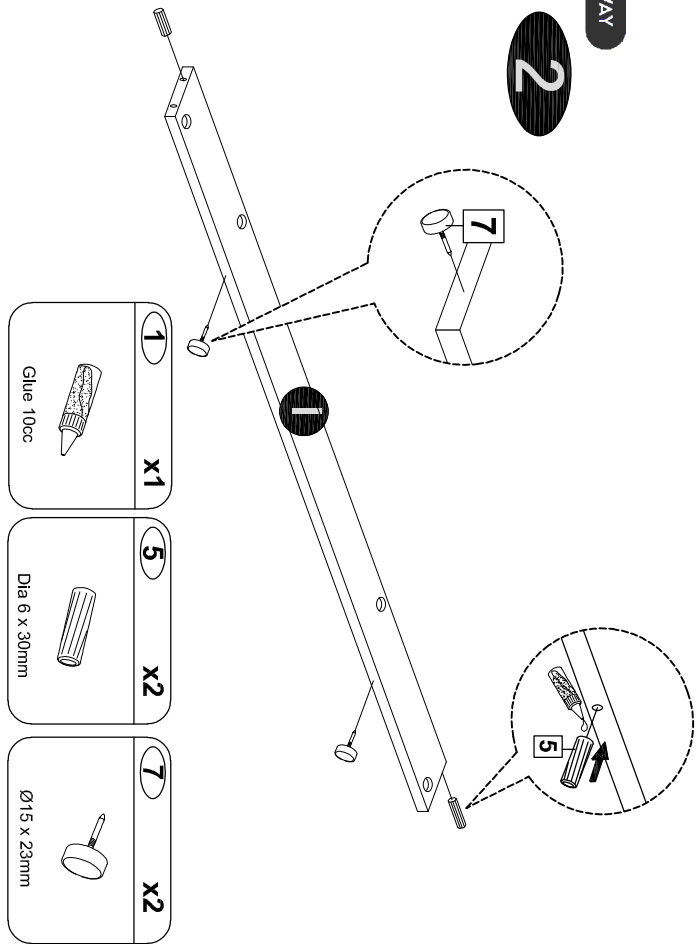

3

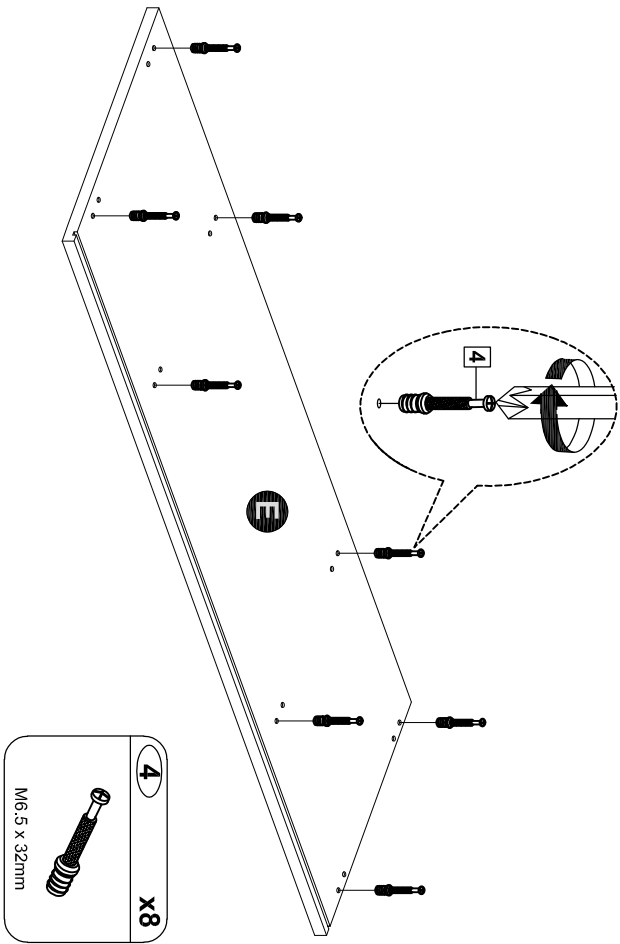

12

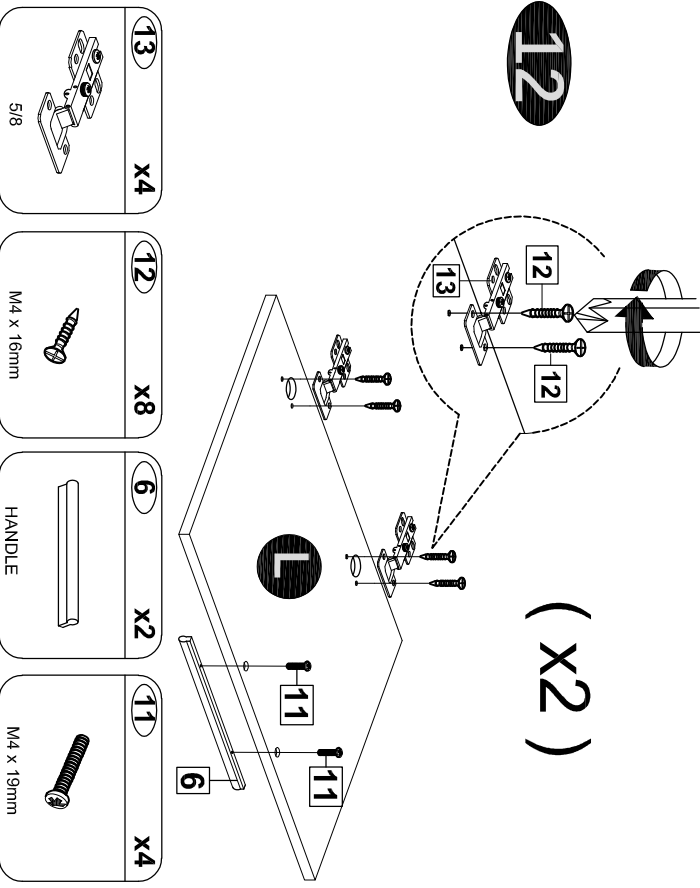

13

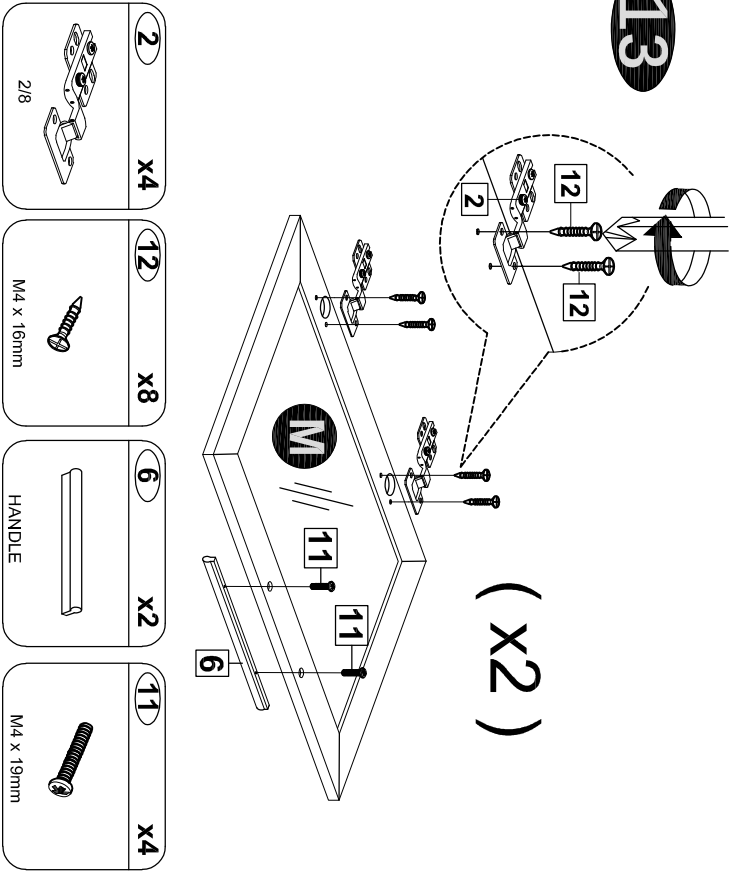

10

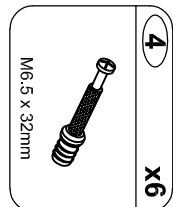
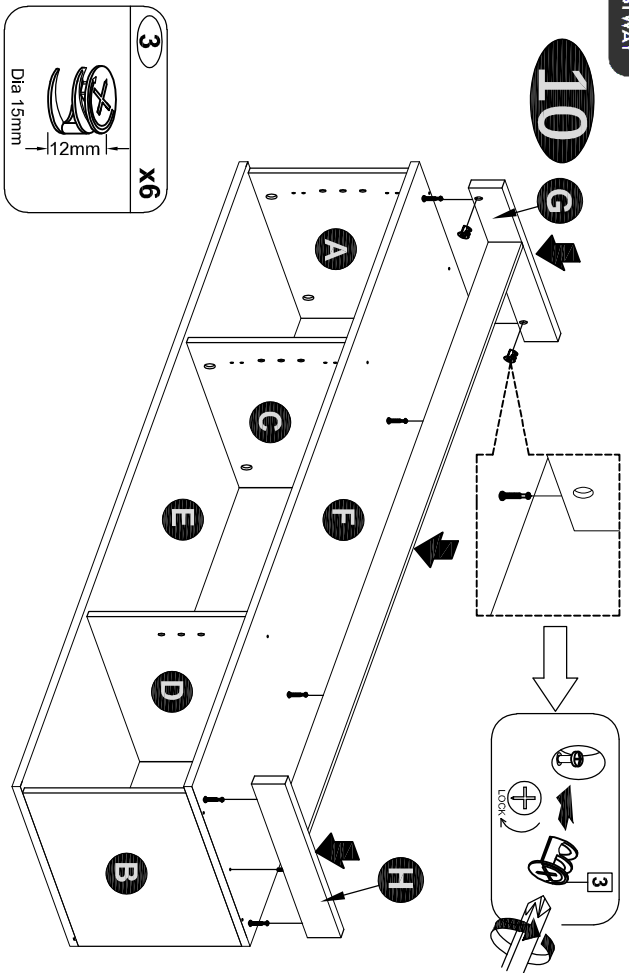

4

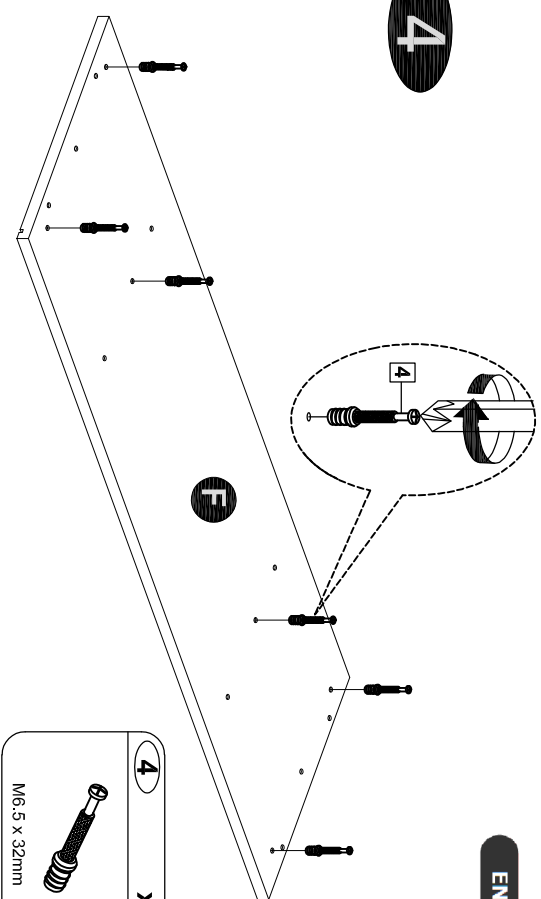

5

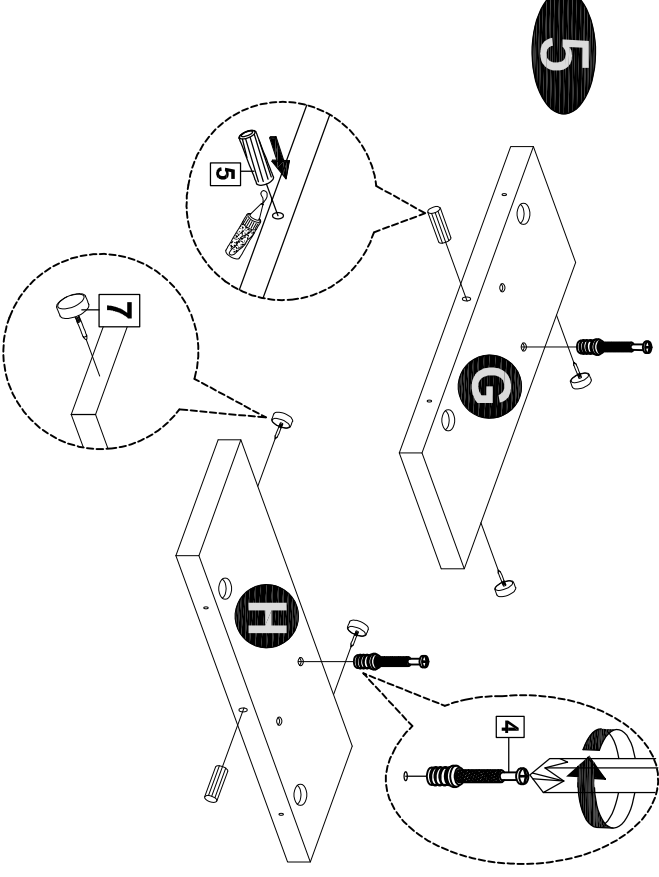

11

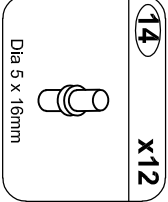
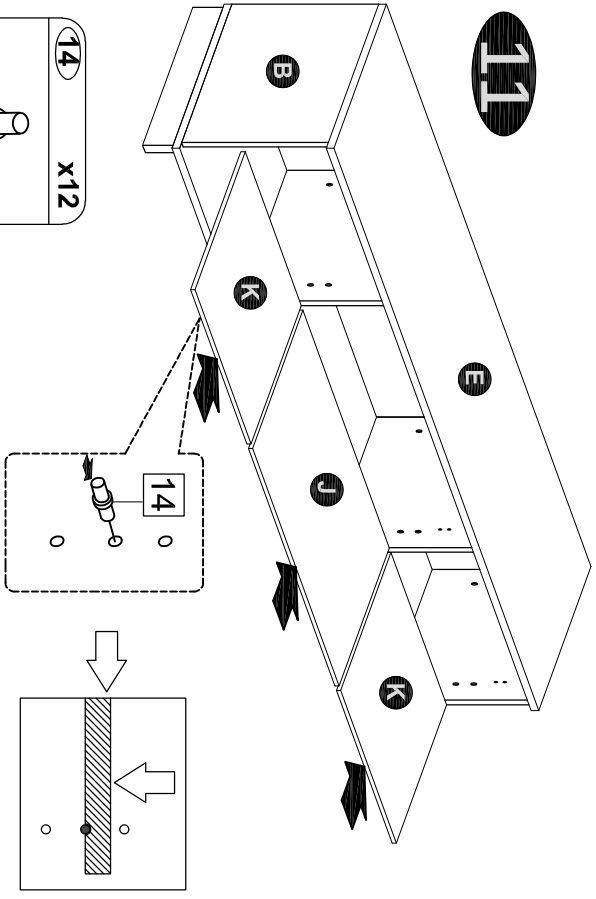

6

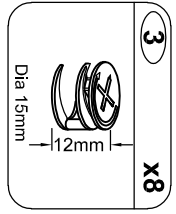
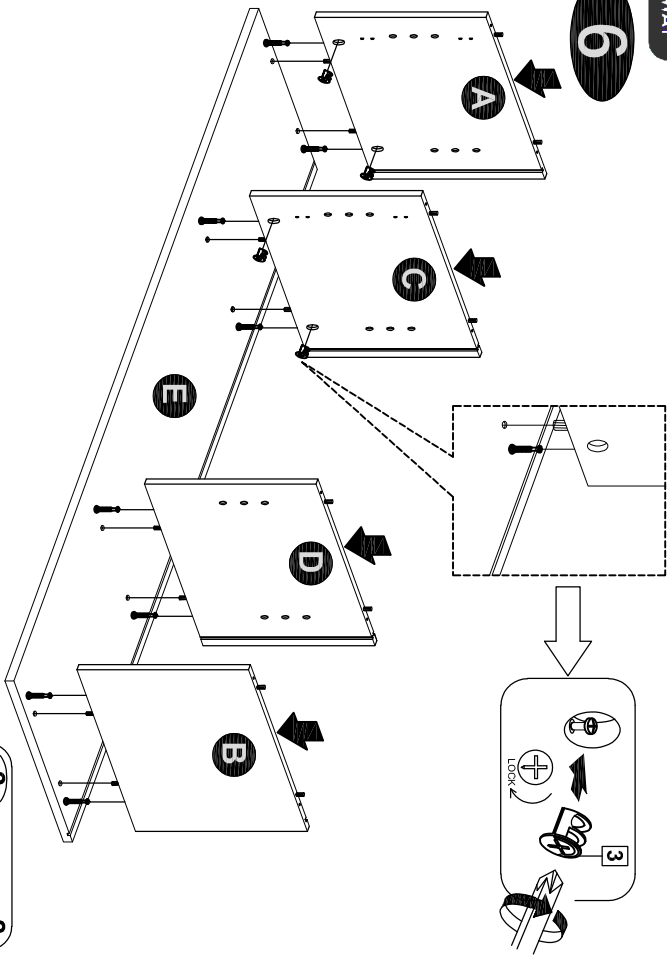

7

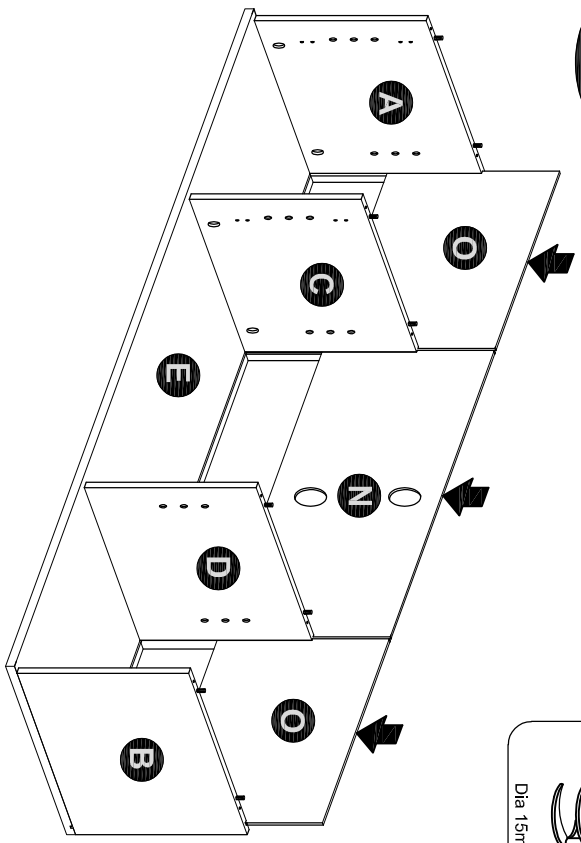

8

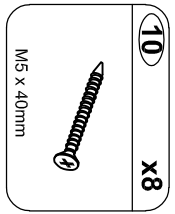
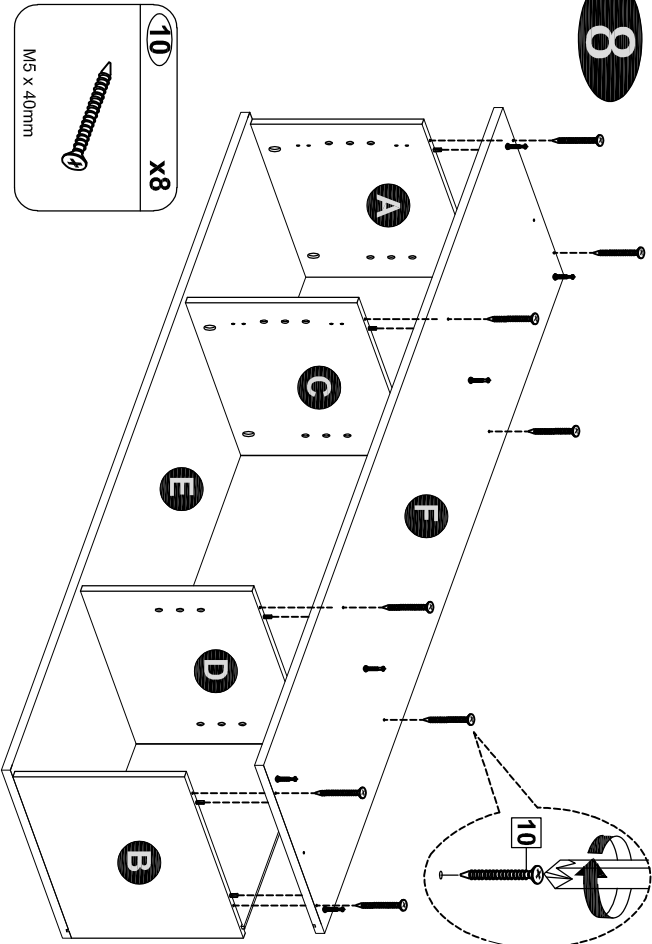

9

