

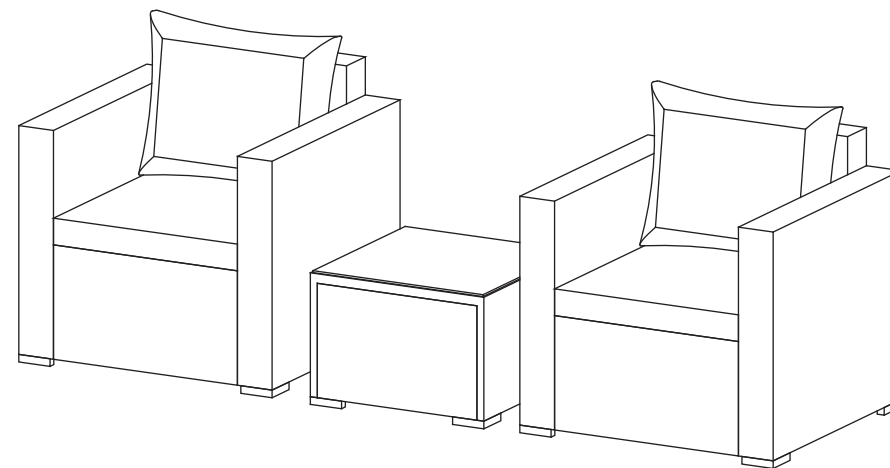

**Please give us a chance to make it right and do better !**

Contact our friendly customer service department for help first.  
Replacements for missing or damaged parts will be shipped ASAP !

US office: Fontana    UK office: Ipswich    AU office: Truganina



## Contact Us !

**Do NOT return this item.**

Contact our friendly customer service department for help first.



US: cs.us@costway.com  
UK: cs.uk@costway.com  
AU: cs.au@costway.com

## USER'S MANUAL

### 3 PIECES WICKER BISTRO SET HW66531

THIS INSTRUCTION BOOKLET CONTAINS **IMPORTANT** SAFETY INFORMATION. PLEASE READ AND KEEP FOR FUTURE REFERENCE.



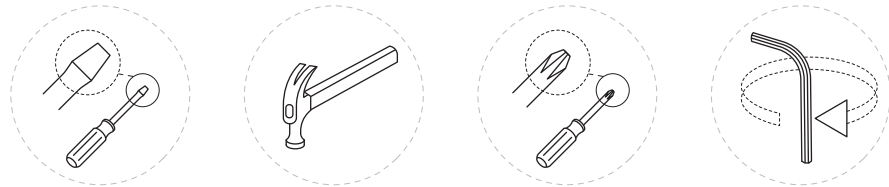

# Before You Start

- ⚠ Read each step carefully before starting. It is very important to ensure each step followed in correct order, otherwise assembly difficulties may occur.
- ⚠ Most of board parts are labeled or stamped on the raw edges. Have a check to make sure all parts are included.
- ⚠ Work in a spacious area, preferably on a carpet close to where the unit will be used.
- ⚠ Keep the handtools close at hand. Do not use power tools to assemble your furniture. They may scratch or damage the parts.

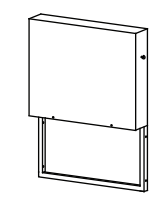
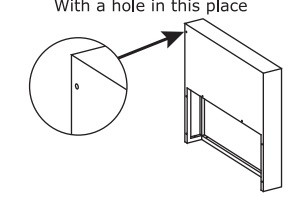
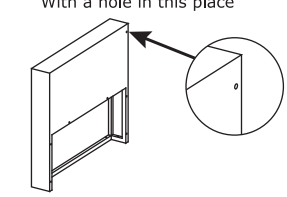
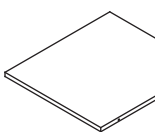
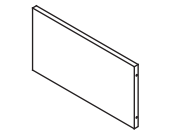
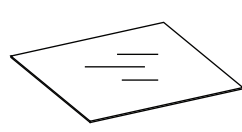
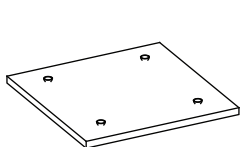
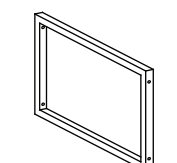
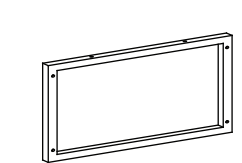
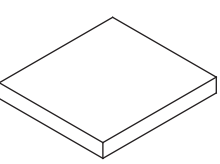
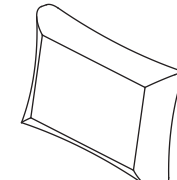
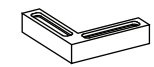
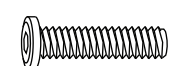

## Part List

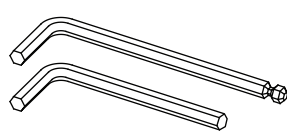
 <b>1</b> x2 pcs Backrest	<p>With a hole in this place</p>  <b>2</b> x2 pcs Left leg	<p>With a hole in this place</p>  <b>3</b> x2 pcs Right leg
 <b>4</b> x2 pcs Seat panel	 <b>5</b> x2 pcs Front leg panel	 <b>6</b> x1 pce Glass top
 <b>7</b> x1 pce Table top	 <b>8</b> x2 pcs Short table side	 <b>9</b> x2 pcs Long Table side
 <b>10</b> x2 pcs Cushion seat	 <b>11</b> x2 pcs Cushion back	 <b>12</b> x12 pcs Plastic feet
 M6x25mm Bolt <b>A</b> x24 pcs	 M6x30mm Bolt <b>B</b> x40 pcs	 Allen Key <b>C</b> x2 pcs

**STEP 1: x2**

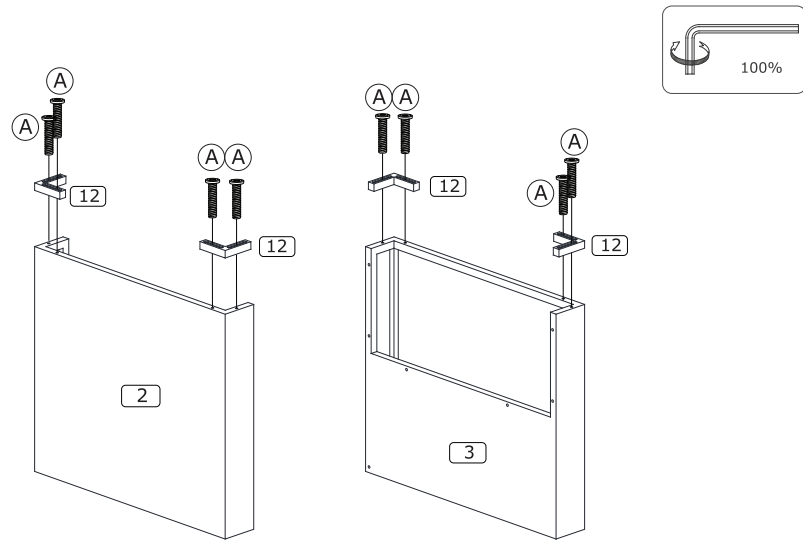

**STEP 2: x2**

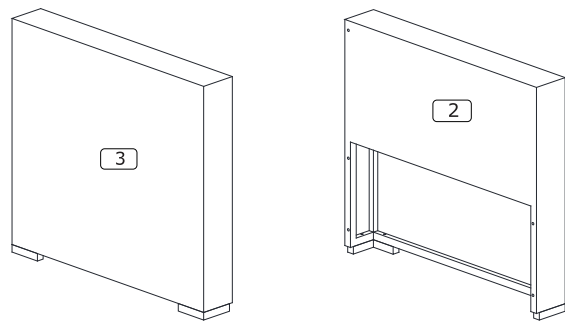

**STEP 3: x2**

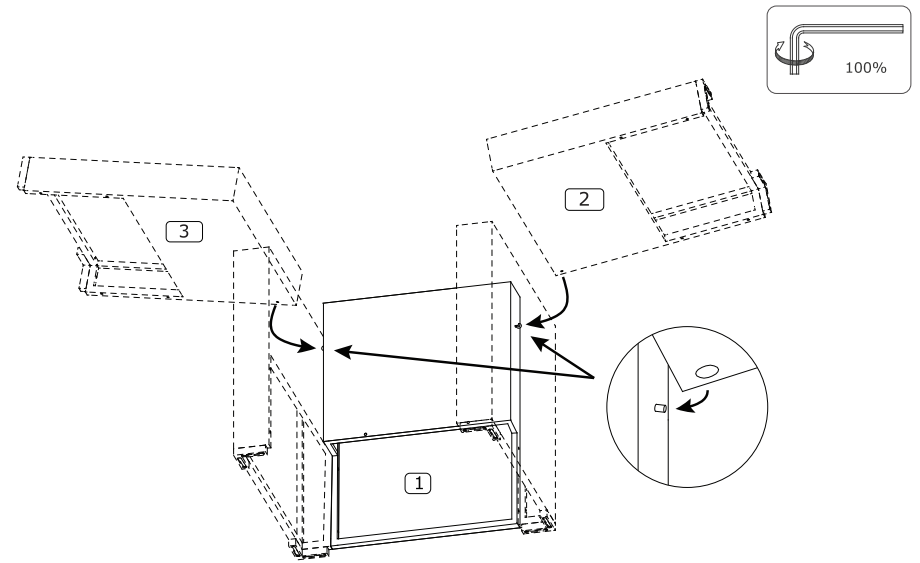

**STEP 4: x2**

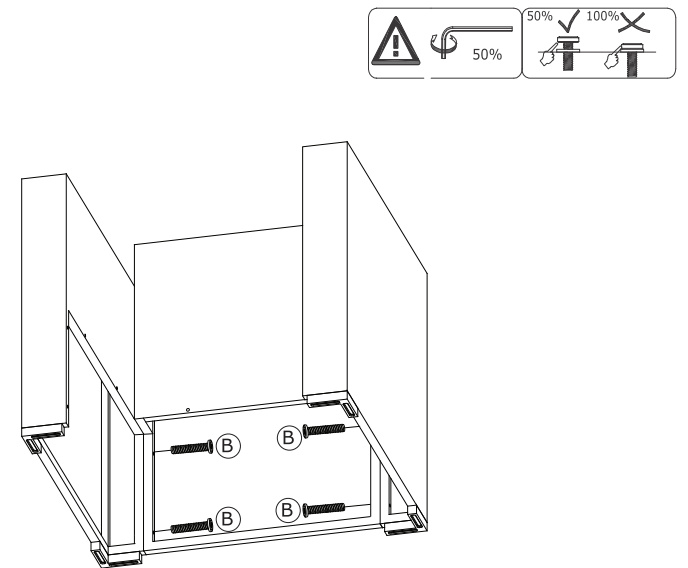

**STEP 5: x2**

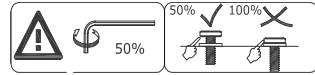
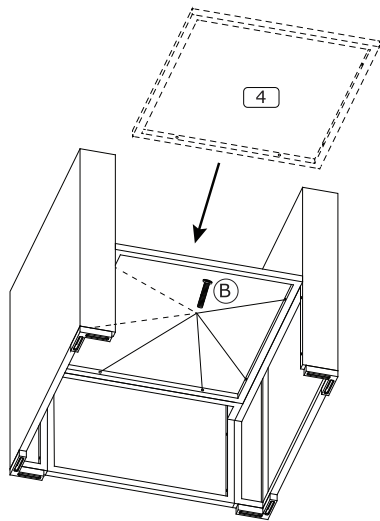

**STEP 7: x2**

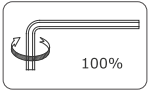
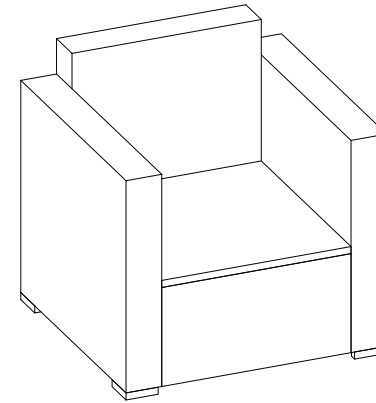

**STEP 6: x2**

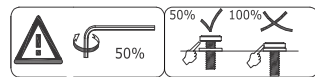
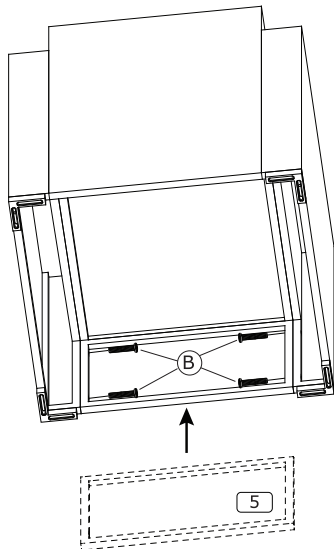

**STEP 8: x2**

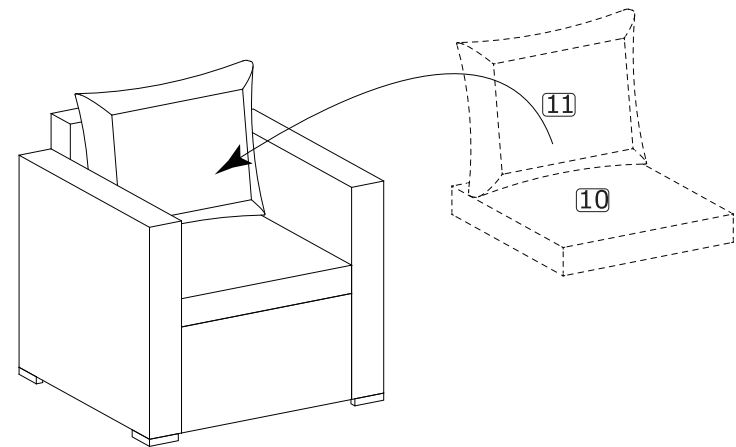

**STEP 9: x2**

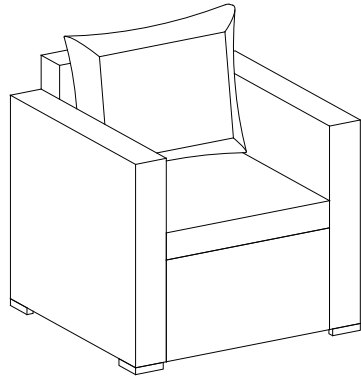

**STEP 10**

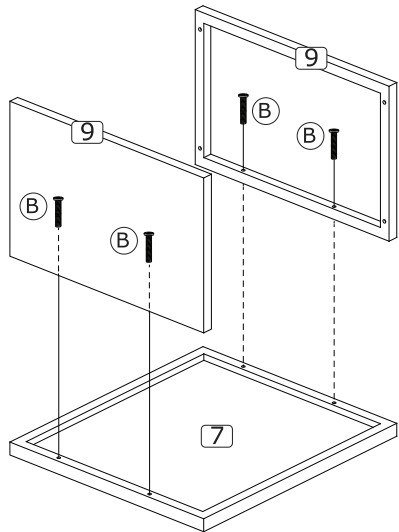
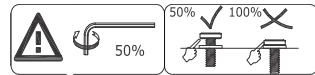

**STEP 11**

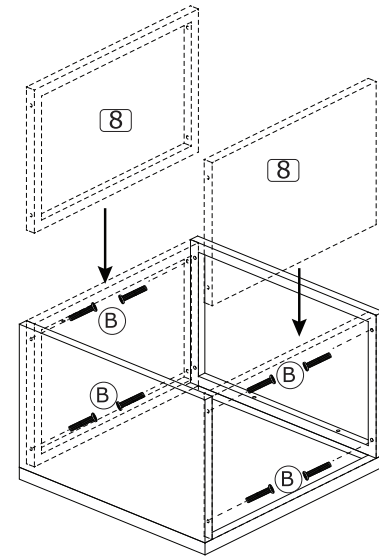
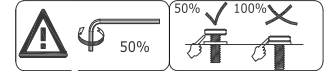

**STEP 12**

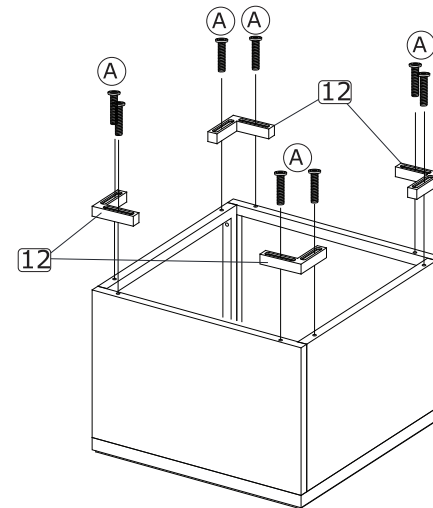
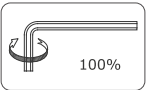

**STEP 13**

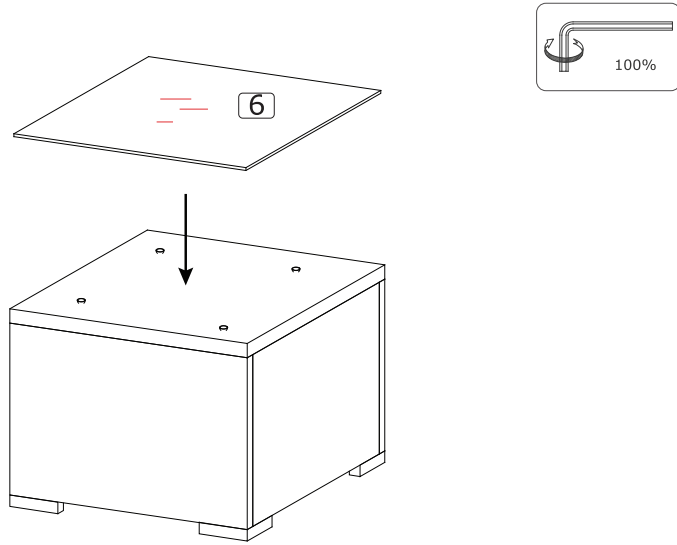

**STEP 14**

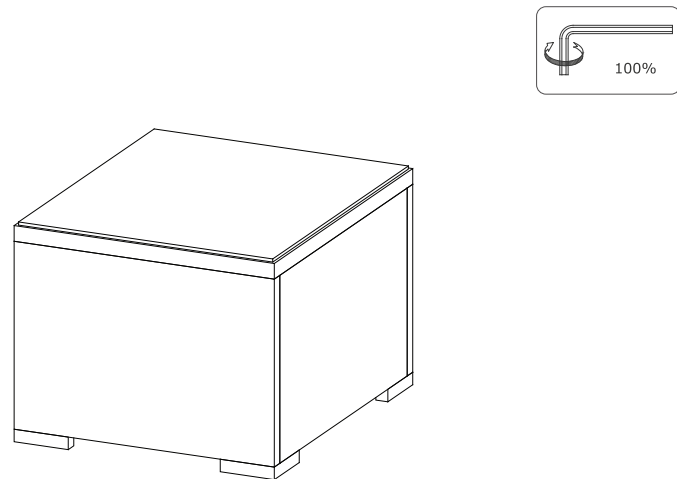

**OPTION 1**

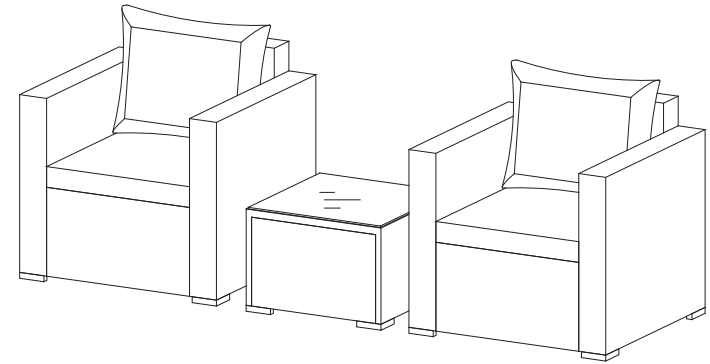

**OPTION 2**

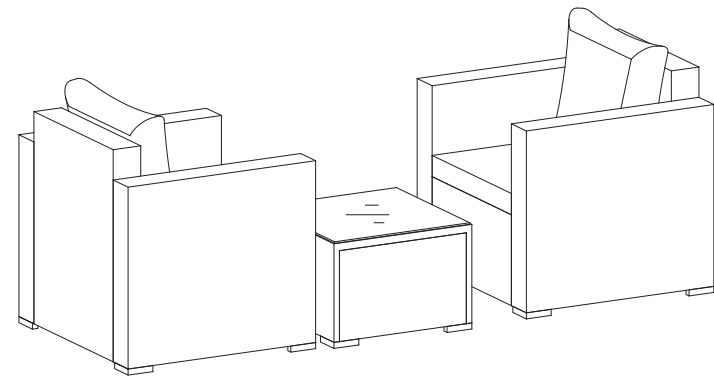

## Care and Maintenance

Use a soft, clean cloth that will not scratch the surface when dusting.

Use of furniture polish is not necessary.

Should you choose to use polish, test first in an inconspicuous area.

Using solvents of any kind on your furniture may damage the finish.

Never use water to clean your furniture as it may cause damage to the finish.

Liquid spills should be removed immediately. Using a soft clean cloth, blot the spill gently. Avoid rubbing.

Check bolts/screws periodically and tighten them if necessary.

## Further advice about wood furniture care

Please protect your outdoor furniture with a cover when not in use since

Long-term sunlight exposure will result in the damage on the surface.

In addition to sunlight damage, wood and metal frame suffers when exposed to extremes in temperature and humidity.

Proper care and cleaning at home will extend the life of your purchase.

Following these important and helpful tips will enhance your furniture as it ages.